

Hybrid Solar Charge Inverter

Product Manual

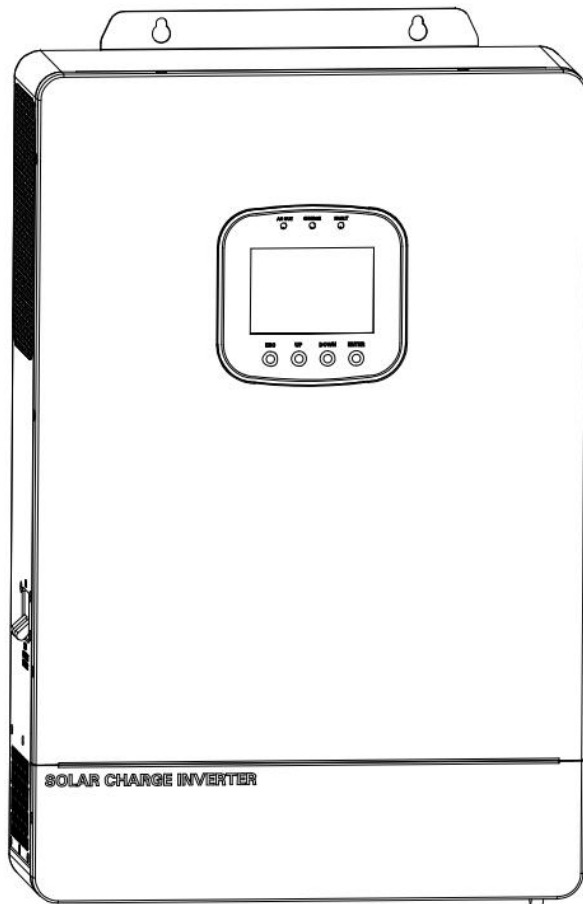

SPI4856V100-500

SPI4862V100-500

SPI4880V150-500

SPI48110V150-500

SPI48120V150-500

SPI4856V100-500P

SPI4862V100-500P

SPI4880V150-500P

SPI48110V150-500P

SPI48120V150-500P

Contents

1. Information on this manual	1
1.1、 Scope	1
1.2、 Target Group	1
1.3、 Safety Instructions	1
1.4、 Introduction	2
1.5、 Product Features	3
2. Product Overview	4
3. Installation	6
3.1、 Unpacking and Inspection	6
3.2、 Preparation	6
3.3、 Mounting the Unit	6
3.4、 Lead-acid Battery Connection	7
3.5、 Lithium Battery Connection	9
3.6、 Lithium battery communication and setting	9
3.7、 LCD setting	9
3.8、 Communicating with battery BMS in parallel system	10
3.9、 AC Input/Output Connection	11
3.10、 PV Connection	13
3.11、 Final Assembly	15
3.12、 Starting inverter	15
4. Operation	16
4.1、 Power ON/OFF	16
4.2、 Operation and Display Panel	16
4.3、 Setup parameters description	20
5. Operating Mode Description	28
5.1、 Charging mode	28
5.2、 Output mode	29
6. Battery type parameters	31
6.1、 For Lead-acid Batteries	31
6.2、 For Lithium Batteries	32
7. Communication	33
7.1、 Overview	33
7.2、 USB communication port	34
7.3、 WIFI communication port	34
7.4、 RS485 communication port	35
7.5、 Dry contact port	35
7.6、 Parallel communication function (parallel operation only)	35
7.7、 Current sharing detection function (parallel operation only)	35
8. Parallel installation and wiring	37
8.1、 Introduction	37
8.2、 Precautions for connecting the parallel connecting lines	37
8.3、 Schematic diagram of parallel connection in single phase	38
8.4、 Schematic diagram of parallel connection in split phase	41

9. Failure codes and countermeasures	46
9.1、 Fault code	46
9.2、 Trouble Shooting	49
10. Protection and Maintenance	52
10.1、 Protections provided	52
10.2、 Maintenance	53
11. Technical parameters	55

1. Information on this manual

This manual describes the assembly, installation, operation and troubleshooting of this unit. Please read this manual carefully before installations and operations. Please keep this manual for future use.

1.1. Scope

This manual provides safety and installation guidance as well as information about tools and wiring.

1.2. Target Group

This document is intended for qualified persons and end users. Tasks that do not require any particular qualification can also be performed by end users. Qualified persons must have the following skills:

- 1、 Knowledge of how an inverter works and is operated.
- 2、 Training in how to deal with the dangers and risks associated with installing and using electrical devices and installations.
- 3、 Training in the installation and commissioning of electrical devices and installations.
- 4、 Knowledge of the applicable standards and directives.
- 5、 Knowledge of and compliance with this document and all safety information.

1.3. Safety Instructions

- 1、 Before using the unit, read all instructions and cautionary marking on the unit, the batteries and all appropriate sections of this manual. The company has the right not to quality assurance, if not according to the instructions of this manual for installation and cause equipment damage.
- 2、 Please be clear which kind of battery system you want, lithium battery system or lead-acid battery system, if you choose the wrong system, energy storage system can't work normally.
- 3、 Do not disassemble the unit. Take it to a qualified service center when service or repair is required. Incorrect re-assembly may result in a risk of electric shock or fire.
- 4、 All the operation and connection please professional electrical or mechanical engineer. All the electrical installation must comply with the local electrical safety standards.
- 5、 **CAUTION**-To reduce risk of injury, charge only deep-cycle lead-acid type rechargeable batteries and lithium batteries. Other types of batteries may burst, causing personal injury and damage.
- 6、 To reduce risk of electric shock, disconnect all wiring before attempting any maintenance or cleaning. Turning off the unit will not reduce this risk.
- 7、 For optimum operation of this inverter, please follow required spec to select appropriate cable size. It's very important to correctly operate this inverter.
- 8、 **GROUNDING INSTRUCTIONS** -This inverter should be connected to a permanent grounded wiring system. Be sure to comply with local requirements and regulation to install this inverter.
- 9、 **NEVER** cause AC output and DC input short circuited. Do NOT connect to the mains when DC input short circuits.
- 10、 Do not install the all-in-one solar charge inverter in harsh environments such as moist, oily, flammable or explosive, or heavily dusty areas.
- 11、 **Warning!** ! Only qualified maintenance personnel can repair this equipment. If the fault persists after

troubleshooting according to the troubleshooting table, take this inverter/charger back to your local dealer or service center for repair.

12. Do not reverse polarity of the battery input; otherwise, the device may be damaged or unpredictable risks may occur.
13. Make sure the inverter is completely assembled, before the operation.
14. Necessary to confirm that the inverter AC output power is the only input device for load, and it is forbidden to use it in parallel with other input AC power to avoid damage.
15. Recommended to attach proper fuse or circuit breaker to the outside of the inverter.

1.4. Introduction

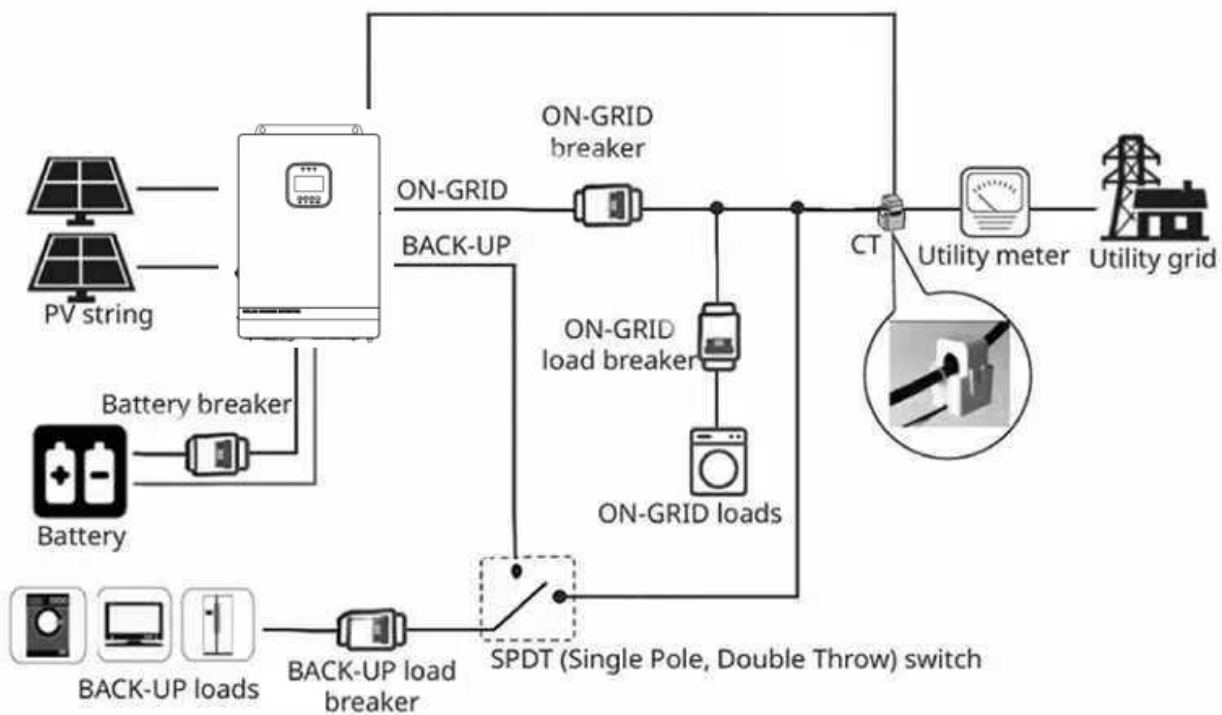

The figure below shows the system application scenario of this product. Specific system wiring method depends on the actual application scenario. A complete system consists of the following parts:

1. PV module: convert light energy into DC power, and charge the battery through the inverter, or directly invert into AC power to drive the load.
2. Mains or generator: connected at the AC input, to power the load while charging the battery. If the mains or generator is not connected, the system can also operate normally, and the load is powered by the battery and PV module.
3. Battery: provided to ensure normal power supply to the system loads when solar energy is insufficient and the Mains is not connected.
4. Household load: allow connection of various household and office loads, including refrigerators, lamps, TVs, fans and air conditioners.
5. All-in-one solar charge inverter: the energy conversion unit of the whole system.
6. WiFi or GPRS: can monitor system permissions remotely.

1.5、 Product Features

- 1、 It has the function of sectional charge and discharge.
- 2、 Allowing access of lead-acid battery and lithium battery.
- 3、 Anti-countercurrent grid-connected function (photovoltaic hybrid power supply), grid-connected mode can be set.
- 4、 It can be used without battery. Solar and utility grid can power loads at the same time.
- 5、 With dual activation function of lithium battery, it can be triggered by any power supply of the mains/photovoltaic.
- 6、 Power saving mode available to reduce no-load loss.
- 7、 Available in four charging modes: Only Solar, Mains Priority, Solar Priority and Mains & Solar hybrid charging.
- 8、 Two output modes: mains bypass and inverter output; uninterrupted power supply.
- 9、 Complete protections, including over voltage and under voltage protection, overload protection, reverse protection, etc ,360° all-round protection with a number of protection functions.
- 10、 ON/OFF rocker switch for AC output control.
- 11、 Full digital voltage and current double closed loop control, advanced SPWM technology, output of pure sine wave.
- 12、 Advanced MPPT technology with an efficiency of 99.9%.
- 13、 Intelligent variable speed fan to efficiently dissipate heat and extend system life.

2. Product Overview

Inverter Models: SPI4856V100-500/SPI4856V100-500P、SPI4862V100-500/SPI4862V100-500P

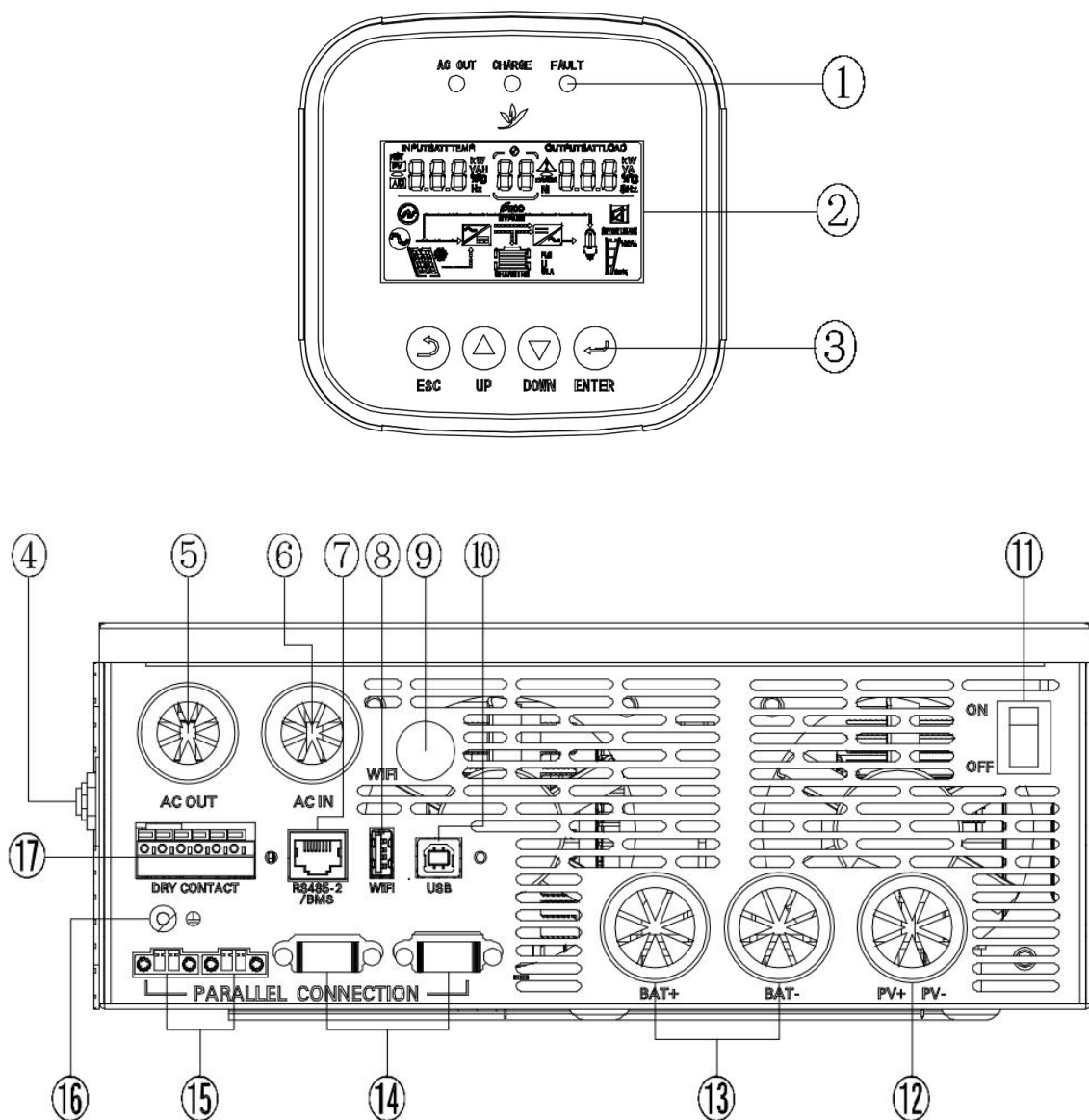

①	Indicator light	⑩	USB communication port
②	LCD screen	⑪	ON/OFF rocker switch
③	Touch the key lightly	⑫	PV port
④	Overload protector	⑬	Battery port
⑤	AC output port	⑭	Parallel communication port (parallel module only)
⑥	AC input port	⑮	Current sharing port (parallel module only)
⑦	RS485-2/BMS communication port	⑯	Grounding screw hole
⑧	WiFi port (optional)	⑰	Dry contact port
⑨	WiFi port (optional)		

Inverter Models: SPI4880V150-500/SPI4880V150-500P、SPI48110V150-500/SPI48110V150-500P、SPI48110V150-500/SPI48110V150-500P

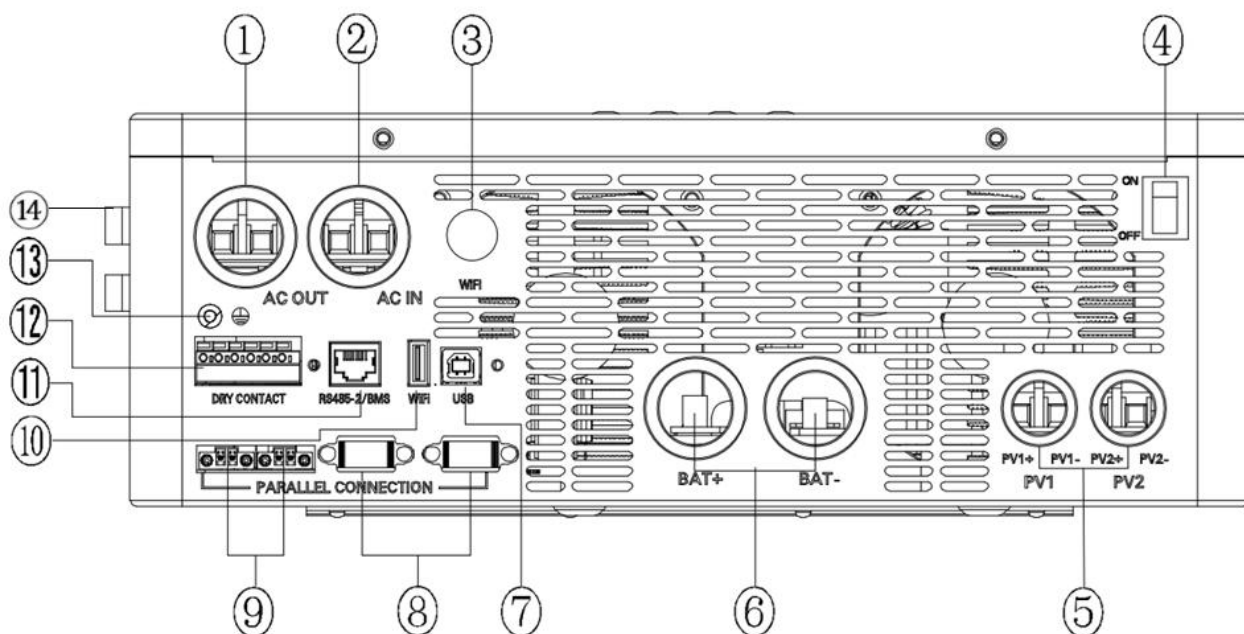

①	AC output port	⑧	Parallel communication port (parallel module only)
②	AC input port	⑨	Current sharing port (parallel module only)
③	WiFi Port (Optional)	⑩	WiFi Port (Optional)
④	ON/OFF rocker switch	⑪	RS485-2/BMS communication port
⑤	PV input port	⑫	Dry junction port
⑥	Battery port	⑬	Ground screw hole
⑦	USB communication port	⑭	Overload protector

3. Installation

3.1. Unpacking and Inspection

Before installation, please inspect the unit. Be sure that nothing inside the package is damaged. You should have received the following items in the package:

- ◆ The unit x 1
- ◆ User manual x 1
- ◆ Ring terminal x 2
- ◆ Dust cap x 2

3.2. Preparation

Before connecting all wiring, please take off bottom cover by removing four screws as shown below.

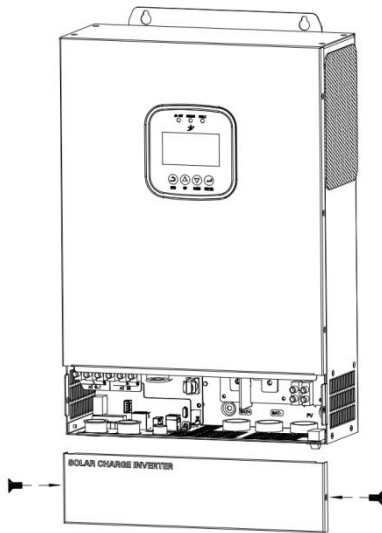

SPI4856V100-500/SPI4856V100-500P
SPI4862V100-500/SPI4862V100-500P

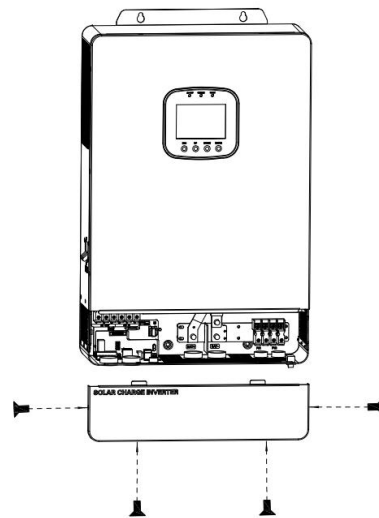

SPI4880V150-500/SPI4880V150-500P
SPI48110V150-500/SPI48110V150-500P
SPI48120V150-500/SPI48120V150-500P

3.3. Mounting the Unit

Consider the following points before selecting where to install:

- Do not install the inverter on flammable building materials.
- Mount on a sturdy surface.
- Install this inverter at eye level in order to allow the LCD display to be read at all times.
- The ambient temperature should be between 0°C and 55°C to ensure optimal operation.
- The recommended installation position is to be adhered to the wall vertically.
- Be sure to keep other objects and surfaces as shown in the right diagram to guarantee sufficient heat dissipation and to have enough space for removing wires.

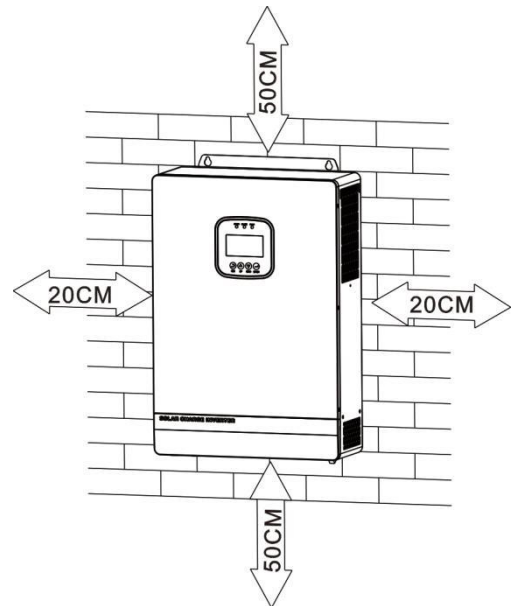

SUITABLE FOR MOUNTING ON CONCRETE OR OTHER NON-COMBUSTIBLE SURFACE ONLY.

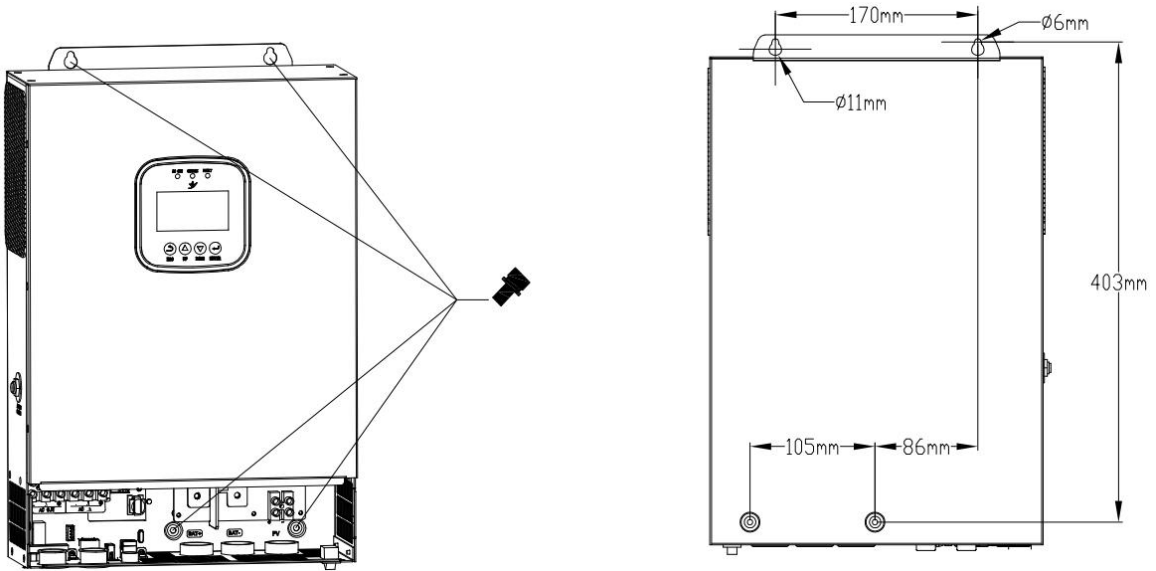

SPI4856V100-500/SPI4856V100-500P
 SPI4862V100-500/SPI4862V100-500P

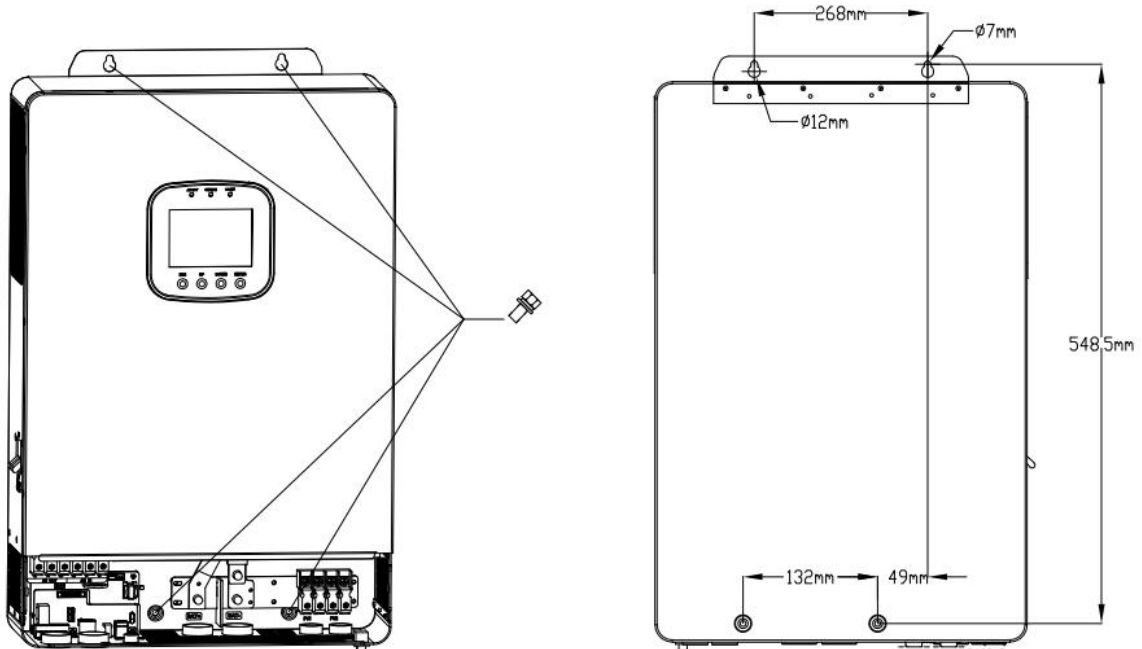

SPI4880V150-500/SPI4880V150-500P
 SPI48110V150-500/SPI48110V150-500P
 SPI48120V150-500/SPI48120V150-500P

Install the unit by screwing four screws. It's recommended to use M4 or M5 screws.

3.4. Lead-acid Battery Connection

User can choose proper capacity lead acid battery with a nominal voltage at 48V. Also, you need to choose battery type as "GEL (default) , SLD or FLD"

CAUTION: For safety operation and regulation compliance, it's requested to install a separate DC over-current protector or disconnect device between battery and inverter. It may not be requested to have a disconnect device in some applications, however, it's still requested to have over-current protection installed. Please refer to typical amperage in below table as required fuse or breaker size.

WARNING! All wiring must be performed by a qualified person.

WARNING! It's very important for system safety and efficient operation to use appropriate cable for battery connection. To reduce risk of injury, please use the proper recommended cable and terminal size as below.

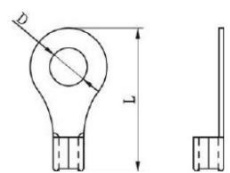



Ring terminal

Recommended battery cable and terminal size:

Models	Wire Size	Rated battery discharge current	Maximum charging current	Recommended air switch or circuit breaker type	Torque value
SPI4856V100-500/ SPI4856V100-500P	30mm ² /2AWG	125A	100A	2P—160A	2-3Nm
SPI4862V100-500/ SPI4862V100-500P	33.6mm ² /2AWG	135A	100A	2P—160A	2-3Nm
SPI4880V150-500/ SPI4880V150-500P	42.4mm ² /1AWG	182A	150A	2P—250A	2-3Nm
SPI48110V150-500/ SPI48110V150-500P	53.5mm ² /0AWG	240A	150A	2P—300A	2-3Nm
SPI48120V150-500/ SPI48120V150-500P	67.4mm ² /00AWG	260A	150A	2P—300A	2-3Nm

Note: For lead acid battery, the recommended charge current is 0.2C(C→battery capacity)

Please follow below steps to implement battery connection:

	<p>WARNING: Shock Hazard</p> <p>Installation must be performed with care due to high battery voltage in series.</p>
	<p>CAUTION!! Do not place anything between the flat part of the inverter terminal and the ring terminal. Otherwise, overheating may occur.</p> <p>CAUTION!! Do not apply anti-oxidant substance on the terminals before terminals are connected tightly.</p> <p>CAUTION!! Before making the final DC connection or closing DC breaker/disconnector, be sure positive (+) must be connected to positive (+) and negative (-) must be connected to negative.</p>

- 1、 Assemble battery ring terminal based on recommended battery cable and terminal size.
- 2、 Connect all battery packs as units requires. It's suggested to connect at least 200Ah capacity battery.
- 3、 Insert the ring terminal of battery cable flatly into battery connector of inverter and make sure the bolts are tightened with torque of 2Nm. Make sure polarity at both the battery and the inverter/charger is correctly connected and ring terminals are tightly screwed to the battery terminals.

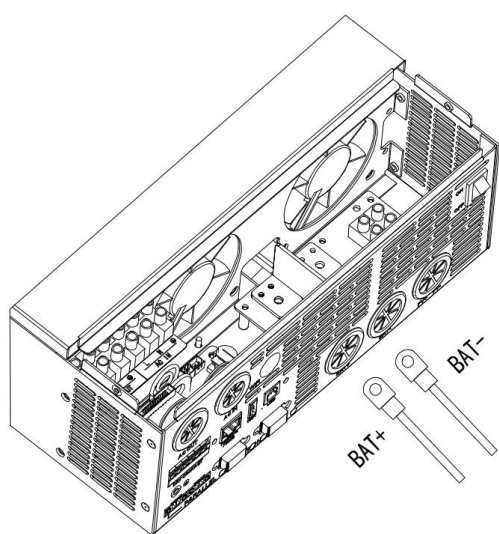

SPI4856V100-500/SPI4856V100-500P
SPI4862V100-500/SPI4862V100-500P

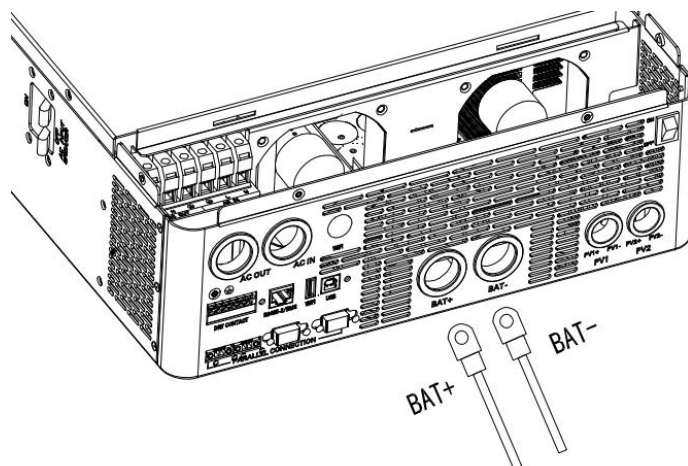

SPI4880V150-500/SPI4880V150-500P
SPI48110V150-500/SPI48110V150-500P
SPI48120V150-500/SPI48120V150-500P

3.5、 Lithium Battery Connection

If choosing lithium battery for SPI, you are allowed to use the lithium battery only which we have configured. There are two connectors on the lithium battery, RJ45 port of BMS and power cable.

Please follow below steps to implement lithium battery connection:

- 1、 Assemble battery ring terminal based on recommended battery cable and terminal size (same as Lead acid, see section Lead-acid Battery connection for details).
- 2、 Insert the ring terminal of battery cable flatly into battery connector of inverter and make sure the bolts are tightened with torque of 2-3Nm. Make sure polarity at both the battery and the inverter/charge is correctly connected and ring terminals are tightly screwed to the battery terminals(same as Lead acid, see section Lead-acid Battery connection for details).
- 3、 Connect the end of RJ45 of battery to BMS communication port(RS485-2/CAN) of inverter.
- 4、 The other end of RJ45 insert to battery communication port(RS485).

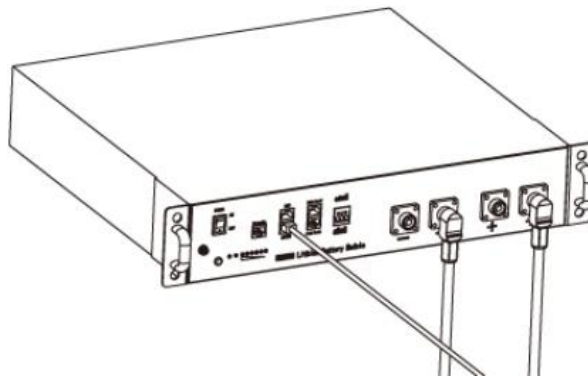

Note: If choosing lithium battery, make sure to connect the BMS communication cable between the battery and the inverter. See Section 3.7 for other Settings.

3.6、 Lithium battery communication and setting

Connect the end of RJ45 of battery to BMS communication port of inverter(RS485-2).

Make sure the lithium battery BMS port connects to the inverter is Pin to Pin, the inverter BMS (RS485-2/BMS) port pin assignment shown as below:

No.	BMS port define (RS485-2/BMS)
1	RS485-B
2	RS485-A
3	--
4	CAN-L
5	CAN-H
6	--
7	RS485-A
8	RS485-B

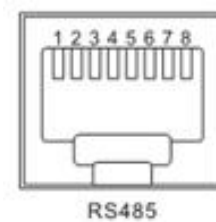

3.7、 LCD setting

When connecting a lithium battery BMS(Only RS485-2 port can be used), match the battery list parameters in section 6 of the inverter according to the battery pack specifications, and set the battery type to the closest one of "LF14/LF15/LF16/ N13/N14" in the inverter **[11]** Settings. At the same time, after setting the

battery type in parameter name **[11]**, switch to parameter name **[23]** to select the communication mode, and finally switch to **[24]** to select the corresponding BMS communication protocol.

11	Battery type1	[11] USE	User-defined; all battery parameters can be set.
		[11] SLd	Sealed lead-acid battery; constant-voltage charge voltage: 57.6V, floating charge voltage: 55.2V.
		[11] FLd	Vented lead-acid battery; constant-voltage charge voltage: 58.4V, floating charge voltage: 55.2V.
		[11] GEL	Colloidal lead-acid battery; constant-voltage charge voltage: 56.8V, floating charge voltage: 55.2V.
		[11] LF14/LF15/LF16 default	Lithium iron phosphate battery LF14/LF15/LF16, corresponding to 14strings ,15 strings and 16 strings of lithium iron phosphate battery; for 16 strings, default constant-voltage charge voltage is 56.8V; for 15 strings, default constant-voltage charge voltage is 53.2V; for 14 strings, default constant-voltage charge voltage is 49.2V; allow adjustable.
		[11] N13/N14	Ternary lithium battery; which is adjustable. The default constant voltage charging voltage of N13 is 53.2V, and the default constant voltage charging voltage of N14 series is 57.6V.
23	RS485-2 /BMS communication	[23] DIS default	RS485-2 Disable the BMS communication. However, our PC and remote monitoring protocol can continue to be used.
		[23] RS485	RS485-2 port for BMS communication.
24	BMS protocol Settings	When the setting Program [23] is RS485, the corresponding lithium battery manufacturer brand needs to be selected for communication	
		VOL=Voltronic、PLN=Pylon、AOG=Aoguan、OLT=Oulite、GXU=Gotion、XWD=Sunwoda、CFE=CF、DAQ=Dyness、PCE=Pace、BST=BST、MIT=Foxess、ACE=AEC、PL3=Pylon-V3.5、MeI=MeZic、TNT=Tentek.	

3.8、 Communicating with battery BMS in parallel system

If need to use communicate with BMS in a parallel system, you should make sure to connect the BMS communication cable between the battery and one inverter of the parallel system. It's recommended to connect to the master inverter of the parallel system.

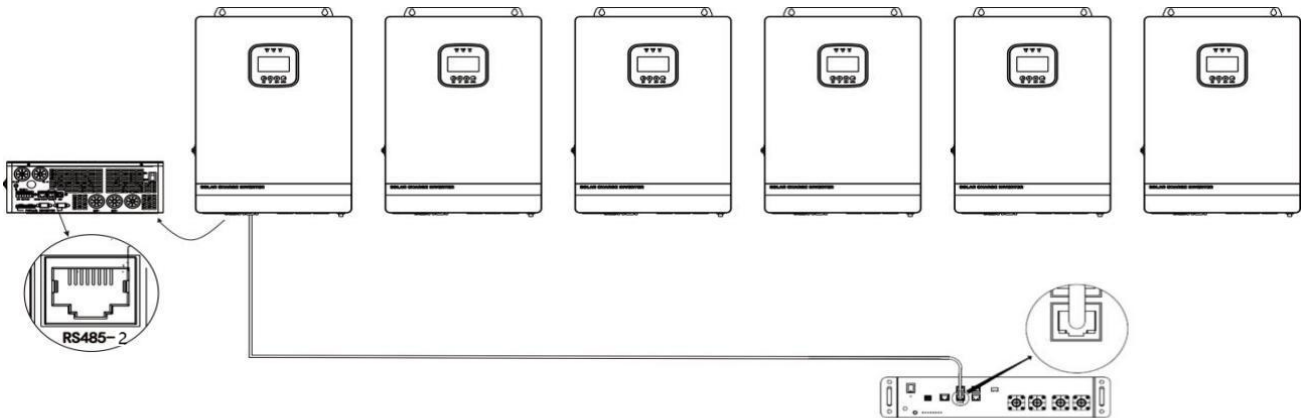

3.9. AC Input/Output Connection

CAUTION!! Before connecting to AC input power source, please install a separate AC breaker between inverter and AC input power source. This will ensure the inverter can be securely disconnected during maintenance and fully protected from over current of AC input.

CAUTION!! There are two terminal blocks with "IN" and "OUT" markings. Please do NOT misconnect input and output connectors.

WARNING! All wiring must be performed by a qualified personnel.

WARNING! It's very important for system safety and efficient operation to use appropriate cable for AC input connection. To reduce risk of injury, please use the proper recommended cable size as below.

Suggested cable requirement for AC wires:

Models	Recommended AC input wiring diameter	Maximum bypass input current	Recommended air switch or circuit breaker type	Torque Value
SPI4856V100-500/ SPI4856V100-500P	3.31mm ² /12AWG	40A	2P—40A	1.2-1.6Nm
SPI4862V100-500/ SPI4862V100-500P				
SPI4880V150-500/ SPI4880V150-500P	8.37mm ² /8AWG	60A	2P—63A	
SPI48110V150-500/ SPI48110V150-500P				
SPI48120V150-500/ SPI48120V150-500P				

Models	Recommended AC output wiring diameter	Maximum bypass output current	Recommended air switch or circuit breaker type	Torque Value
SPI4856V100-500/ SPI4856V100-500P	3.31mm ² /12AWG	40A	2P—40A	1.2-1.6Nm
SPI4862V100-500/ SPI4862V100-500P				

SPI4880V150-500/ SPI4880V150-500P	8.37mm ² /8AWG	60A	2P—63A	1.2-1.6Nm
SPI48110V150-500/ SPI48110V150-500P				
SPI48120V150-500/ SPI48120V150-500P				

Please follow below steps to implement AC input/output connection:

- 1、 Before making AC input/output connection, be sure to open DC protector or disconnect first.
- 2、 Remove insulation sleeve 10mm for six conductors. And shorten phase L and neutral conductor 3 mm.
- 3、 Insert AC input wires according to polarities indicated on terminal block and tighten the terminal screws. Be sure to connect PE protective conductor  first.

-  →Ground (yellow-green)
- L→LINE(brown or black)
- N→Neutral(blue))

 **WARNING:**
Make sure to disconnect the power supply before trying to harden the AC power supply to this machine.

- 4、 Then, insert AC output wires according to polarities indicated on terminal block and tighten terminal screws. Be sure to connect PE  protective conductor first.

-  →Ground (yellow-green)
- L→LINE(brown or black)
- N→Neutral(blue))

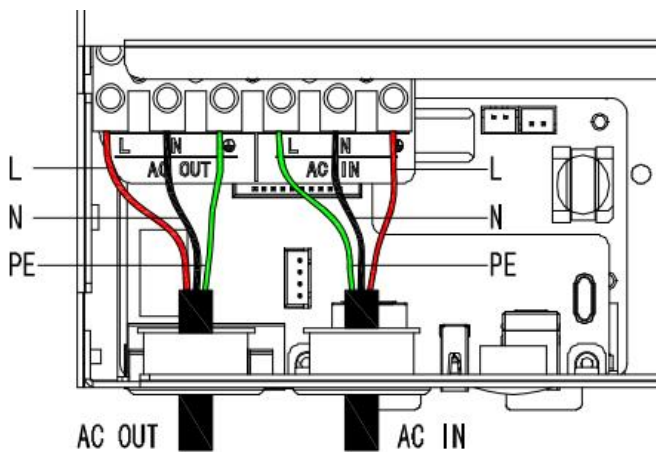

SPI4856V100-500/SPI4856V100-500P
SPI4862V100-500/SPI4862V100-500P

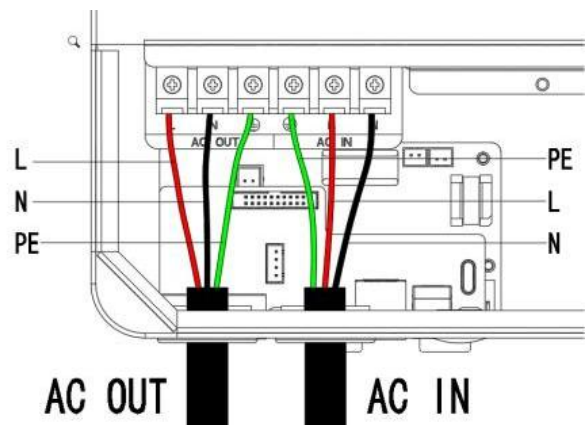

SPI4880V150-500/SPI4880V150-500P
SPI48110V150-500/SPI48110V150-500P
SPI48120V150-500/SPI48120V150-500P

- 5、 Make sure the wires are securely connected.

CAUTION: Important

Be sure to connect AC wires with correct polarity. If L and N wires are connected reversely, it may cause utility short-circuited when these inverters are worked in parallel operation.

CAUTION: Appliances such as air conditioner are required at least 2~3 minutes to restart because it's required to have enough time to balance refrigerant gas inside of circuits. If a power shortage occurs and recovers in a short time, it will cause damage to your connected appliances. To prevent this kind of damage, please check with manufacturer of air conditioner that if it's equipped with time-delay function before installation. Otherwise, this off grid solar inverter will trigger overload fault and cut off output to protect your appliance but sometimes it still causes internal damage to the air conditioner.

3.10、 PV Connection

CAUTION: Before connecting to PV modules, please install separately a DC circuit breaker between inverter and PV modules.

WARNING! All wiring must be performed by a qualified personnel.

WARNING! It's very important for system safety and efficient operation to use appropriate cable for PV module connection. To reduce risk of injury, please use the proper recommended cable size as below.

Models	Recommended PV wiring diameter	Maximum PV input current	Recommended air switch or circuit breaker type	Torque value
SPI4856V100-500/ SPI4856V100-500P	5.2mm ² /10AWG	22A	2P—32A	1.2-1.6Nm
SPI4862V100-500/ SPI4862V100-500P		27A		
SPI4880V150-500/ SPI4880V150-500P		22A+22A		
SPI48110V150-500/ SPI48110V150-500P				
SPI48120V150-500/ SPI48120V150-500P		27A+27A		

PV Module Selection:

When selecting proper PV modules, please be sure to consider below parameters:

1. Open circuit Voltage (Voc) of PV modules not exceeds max. PV array open circuit voltage of inverter.
2. Open circuit Voltage (Voc) of PV modules should be higher than min. battery voltage.

INVERTER MODEL	Max. PV Array Open Circuit Voltage	Start-up Voltage	PV Array MPPT Voltage Range
SPI4856V100-500/ SPI4856V100-500P	500Vdc	120Vdc	90Vdc~450Vdc
SPI4862V100-500/ SPI4862V100-500P			
SPI4880V150-500/ SPI4880V150-500P			
SPI48110V150-500/ SPI48110V150-500P			
SPI48120V150-500/ SPI48120V150-500P			

Please follow below steps to implement PV module connection:

1. Remove insulation sleeve 10 mm for positive and negative conductors.

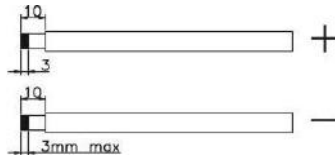

2. Check correct polarity of connection cable from PV modules and PV input connectors. Then, connect positive pole (+) of connection cable to positive pole (+) of PV input connector. Connect negative pole (-) of connection cable to negative pole (-) of PV input connector.

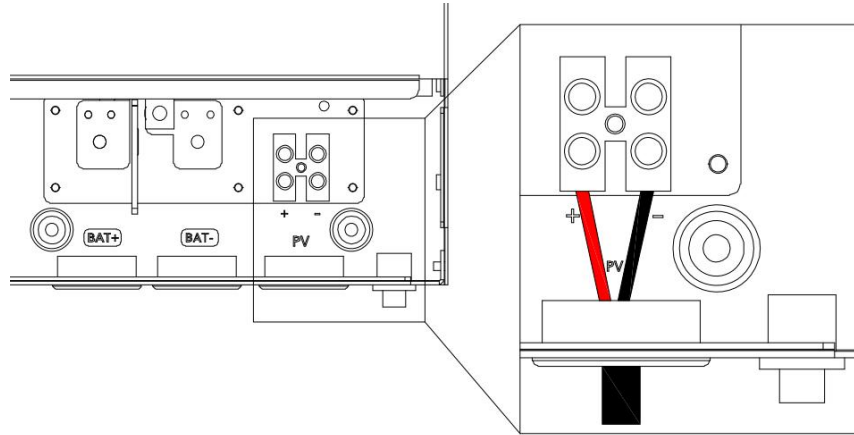

SPI4856V100-500/SPI4856V100-500P
 SPI4862V100-500/SPI4862V100-500P

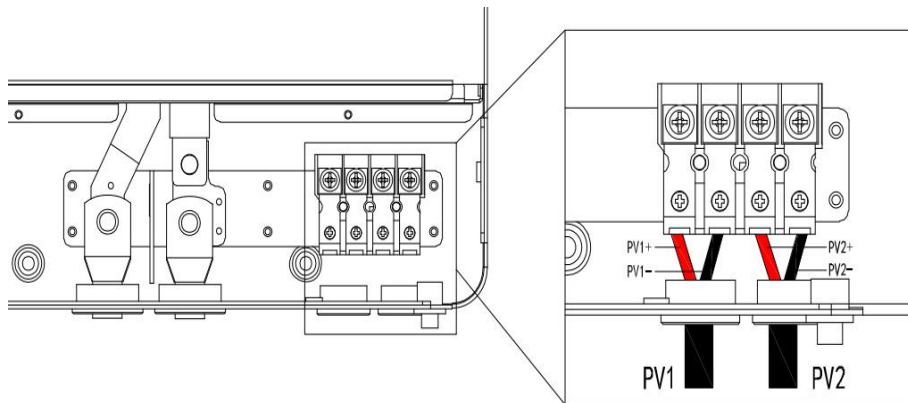

SPI4880V150-500/SPI4880V150-500P
 SPI48110V150-500/SPI48110V150-500P
 SPI48120V150-500/SPI48120V150-500P

3. Make sure the wires are securely connected.

3.11、 Final Assembly

After all the lines are connected, put the bottom cover and tighten the screws according to the model of the inverter.

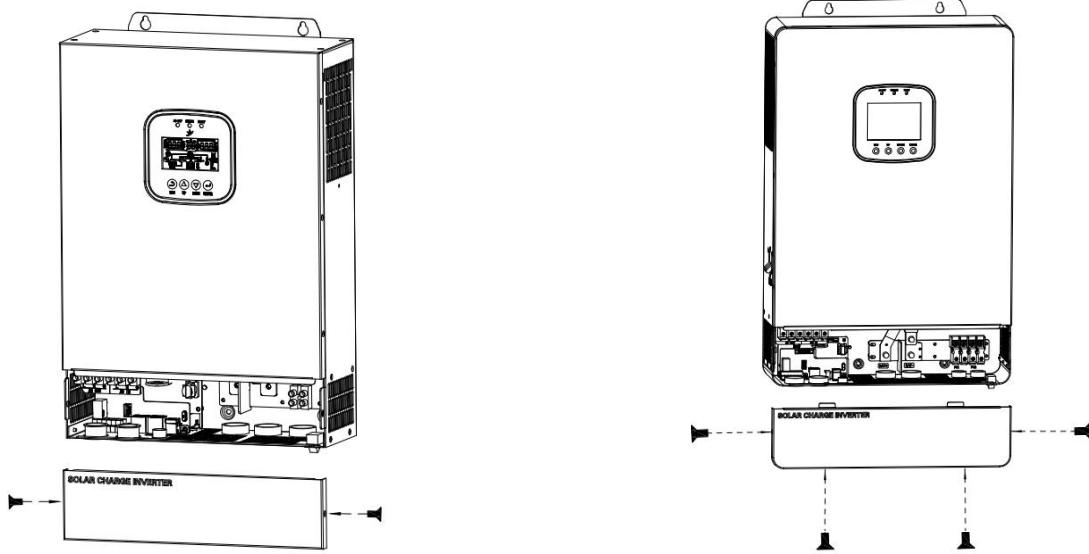

SPI4856V100-500/SPI4856V100-500P
SPI4862V100-500/SPI4862V100-500P

SPI4880V150-500/SPI4880V150-500P
SPI48110V150-500/SPI48110V150-500P
SPI48120V150-500/SPI48120V150-500P

The installation diagram of the dust cover is as follows.

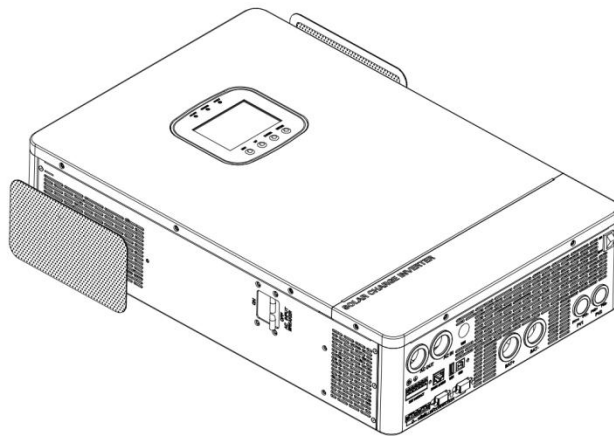

3.12、 Starting inverter

Step 1: Close the battery circuit breaker.

Step 2: Press the rocker switch at the bottom of the inverter, and the screen and indicator light up, indicating that the inverter has been activated.

Step 3: Close the circuit breakers of PV, AC input and AC output in turn.

Step 4: Start the load one by one according to the order of power from small to large.

4. Operation

4.1. Power ON/OFF

Once the unit has been properly installed and the batteries are connected well, simply press On/Off switch (located on the bottom of the case) to turn on the unit.

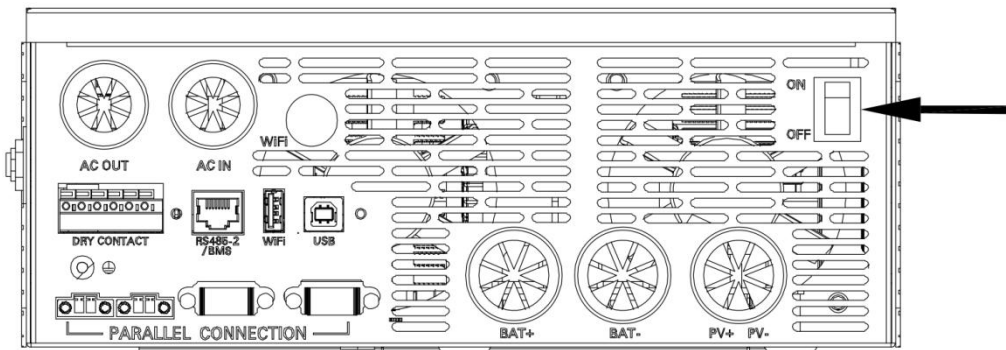

SPI4856V100-500/SPI4856V100-500P
 SPI4862V100-500/SPI4862V100-500P

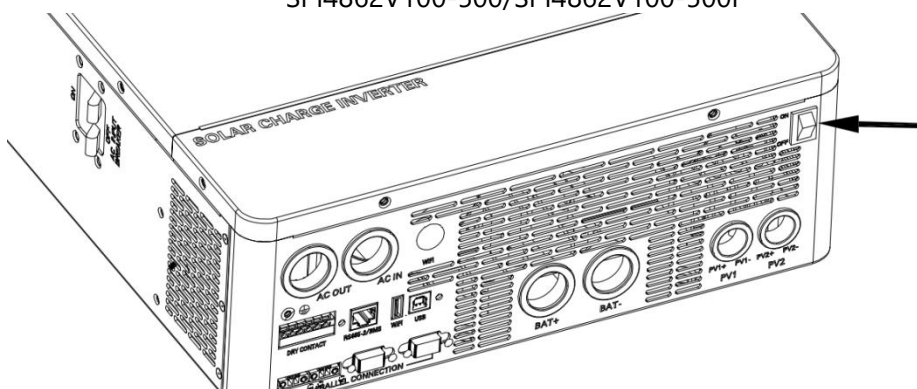

SPI4880V150-500/SPI4880V150-500P
 SPI48110V150-500/SPI48110V150-500P
 SPI48120V150-500/SPI48120V150-500P

4.2. Operation and Display Panel

The operation and display panel, shown in below chart, is on the front panel of the inverter. It includes three indicators, four function keys and a LCD display, indicating the operating status and input/output power information.

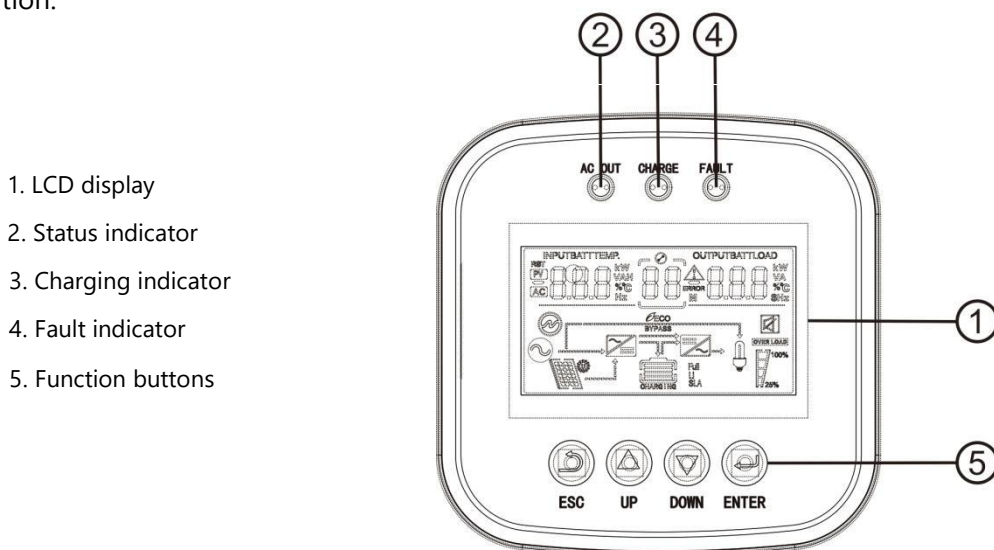

1. LCD display
2. Status indicator
3. Charging indicator
4. Fault indicator
5. Function buttons

Indicators introduction:

Indicators	Colors	Description
------------	--------	-------------

AC OUT	Green	Steady on: Mains output
		Flash: Inverter output
CHARGE	Yellow	Flash: Fast charging
		Steady on: Floating charge
FAULT	Red	Flash : Fault state







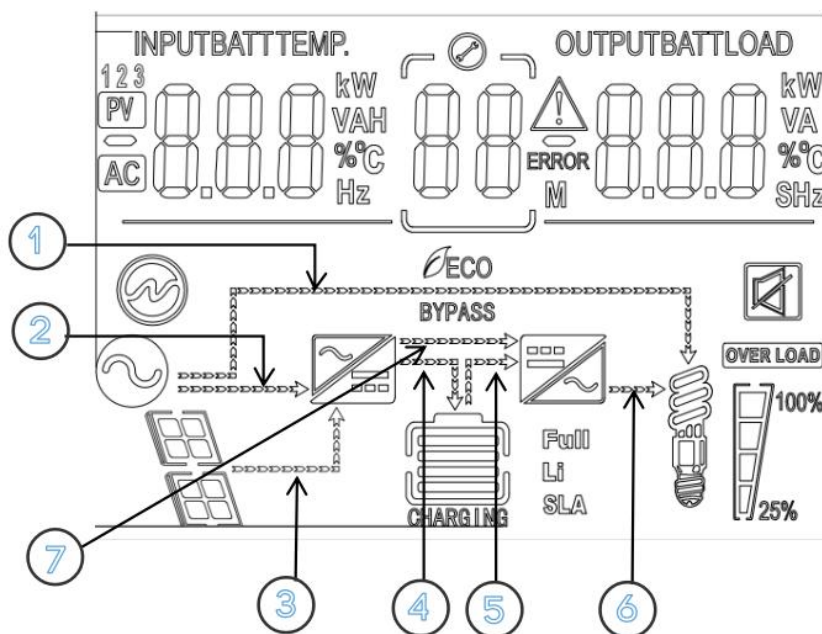



















Operation buttons introduction:

Function buttons	Description
ESC	To exit setting mode
UP	Previous choice
DOWN	Next choice
ENTER	To confirm the selection in setting mode or enter setting mode

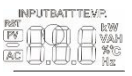
LCD screen introduction:



Icons	Functions	Icons	Functions
	Indicates that the AC input terminal has been connected to the grid		Indicates that the inverter circuit is working
	Indicates that the AC input mode in APL mode (wide voltage range)	BYPASS	Indicates that the machine is in the Mains Bypass mode
	Indicates that the PV input terminal has been connected to the solar panel	OVER LOAD	Indicates that the AC output is in an overload state
	Indicates that the machine has been connected to the battery: indicates that the		Indicates the percentage of AC output loads: indicates that the load percentage is

	<p>remaining battery is 0%~24%;</p> <p> indicates that the remaining battery is 25%~49%;</p> <p> indicates that the remaining battery is 50%~74%;</p> <p> indicates that the remaining battery is 75%~100%.</p>		<p>0%~24%;</p> <p> indicates that the load percentage is 25%~49%;</p> <p> indicates that the load percentage is 50%~74%;</p> <p> indicates that the load percentage is $\geq 75\%$</p>
	Indicates that the battery type of the machine is a lithium battery		Indicates that the buzzer is not enabled
	Indicates that the current battery type of the machine is a lead-acid battery		Indicates that the machine has an alarm
	Indicates that the battery is in charging state		Indicates that the machine is in a fault condition
	Indicates that the AC/PV charging circuit is working		Indicates that the machine is in setup mode
	Indicates that the AC output terminal has an AC voltage output		<p>The parameters displayed in the middle of the screen:</p> <ol style="list-style-type: none"> In the non-setup mode, the alarm or fault code is displayed. In the setup mode, the currently set parameter item code is displayed.
	In parallel operation, this icon indicates that this inverter is the host, which is only valid in parallel mode.		
Parameters display on the left side of the screen: input parameters			
	Indicates AC input		
	Indicates PV input		
	Indicates the PV1 /PV 2 input		
	Display battery voltage, battery charge total current, mains charge power, AC input voltage, AC input frequency, PV input voltage, internal heat sink temperature, software version		
Parameters display on the right side of the screen: Output parameters			
	Indicates output voltage, output current, output active power, output apparent power, battery discharge current, software version; in setup mode, displays the set parameters under the currently set parameter item code		
Arrow display			
	Indicates the grid supplying power to the load		Indicates the charging circuit charging the battery terminal
	Indicates grid supplying		Indicates the battery

	power to the charging circuit		terminal supplying power to the inverter circuit
③	Indicates PV module supplying power to the charging circuit	⑥	Indicates the inverter circuit supplying power to the load
⑦	The arrow is not displayed		

Real-time data viewing method

On the LCD main screen, press the "UP" and "DOWN" buttons to scroll through the real-time data of the machine.

page number	The left side of the screen parameter	In the middle of the screen parameters	The right side of the screen parameter
0	cell voltage; battery voltage	Fault code	output voltage
1	Battery voltage collected by the BMS (Display only after BMS communication is normal)		Battery capacity rate acquired by BMS (Display only after BMS communication is normal)
2	battery current		power of battery [cell]
3	AC output		AC output active power
4	AC output frequency		The AC output sees the power
5	AC input current		AC input voltage
6	AC incoming frequency		AC input depends power
7	The PV1 input voltage		PV1 input power
8	PV2 input voltage		PV2 input power
9	PV heat sink temperature		The PV is input to the total power
10	Inverter heat sink temperature		busbar voltage
11	Program larger version		Program version
12	Battery rated voltage		Output rated power
13	PV rated voltage		PV rated charging current
14	Machine ID No		Inverter in parallel machine mode

4.3. Setup parameters description

Buttons operation instructions: Press the "SET" button to enter the setup menu and exit the setup menu. After entering the setup menu, the parameter number [00] will flash. At this point, press the "UP" and "DOWN" buttons to select the code of parameter item to be set. Then, press the "ENT" button to enter the parameter editing mode, and the value of the parameter is flashing. Adjust the value of the parameter with the "UP" and "DOWN" buttons. Finally, press the "ENT" button to complete the parameter editing and return to the parameter selection state.

Note: in parallel mode, all machines will synchronize the setting parameters of the host (the machine with "M" is displayed on the display screen) before startup. After startup, the setting parameters of any machine will be synchronized to other machines in the system

Parameter no.	Parameter name	Settings	Description
00	Exit setting menu	[00] ESC	Exit the setup menu
01	Output source priority	[01] PV	PV priority mode, switching to the Mains when the PV fails or the battery is lower than the set value of parameter [16].
		[01] GID (default)	Mains priority mode, switching to inverter only when the mains fails.
		[01] BAT	Battery priority mode. Switch to mains power only when the battery is under voltage or lower than the setting value of parameter [16]; Switch to battery discharge only when the battery is fully charged or higher than the setting value of parameter [17].
		[01] HBR	Hybrid mode, you can set this mode through the [33] setting item.
02	AC output voltage setting	[02] 230V	Allow to set to 200Vac/208Vac/220Vac/230Vac/240 Vac, default 230V. The rated output power will be reduced= (Power Rate)*(Vset/230)
03	Output Frequency	[03] 50.0HZ	Bypass self-adaptation; when the mains is connected, it automatically adapts to the mains frequency; when the mains is disconnected, the output frequency can be set through this menu. The default output frequency to 50Hz of the 230V.
		[03] 60.0HZ	
04	AC Input Voltage Range	[04] UPS (default)	Narrow mains input voltage range of 230Vac machine: 170~280Vac; Frequency range: 47~ 55Hz (50Hz);57Hz ~ 65Hz (60Hz);
		[04] APL	Wide mains input voltage range of 230Vac machine: 90~280Vac; Frequency range: 47~ 55Hz (50Hz);

Parameter no.	Parameter name	Settings	Description
			57Hz ~ 65Hz (60Hz);
		[04] GEN	Diesel generators input, need to set this mode, at this time: Narrow Ac input voltage range of 230Vac machine: 90~280Vac Frequency range: 40~ 70Hz
05	Power saving mode	[05] DIS (default)	Power saving mode disabled.
		[05] ENA	After the power saving mode is enabled, if the load is null or less than 25W, the inverter output is turned off after a delay for a certain period of time. When the load is more than 50W, the inverter automatic restart.
06	Charger source priority	[06] OSO	PV priority charging; only when the PV charging fails, the mains charging is started.
		[06] OOU	Mains priority charging; only when the mains charging fails, the PV charging is started.
		[06] SNU (default)	PV and Mains hybrid charging; PV charging is a priority, and when the PV energy is insufficient, the Mains charging supplements. When the PV energy is sufficient, the Mains charging stops. Note: Only when the Mains bypass output is loaded, the PV charging and the mains charging can work at the same time. When the inverter works, only the PV charging can be started.
		[06] NUC	Only PV charging, with the Mains charging not activated.
07	Max total charging current	[07] 80A (default)	Maximum total charging current setting. 5.6KW-6.2KW Setting range: 0~100A; 8KW-11KW-12KW Setting range: 0~150A;
08	Max PV charger current	[08] 80A (default)	Max PV charger current. 5.6KW-6.2KW Setting range: 0~100A; 8KW-11KW-12KW Setting range: 0~150A;
09	Max AC charger current	[09] 60A (default)	The maximum current setting that allows the mains to charge the battery, 5.6KW-6.2KW Setting range: 0~80A; 8KW Setting range: 0~ 120A; 11KW-12KW Setting range: 0~150A;

Parameter no.	Parameter name	Settings	Description
10	Battery fully charging current setting	[10] 3A (default)	When the battery type is lead-acid, when the battery voltage is greater than or equal to the floating charge value, and the charging current is less than the setting value, the battery is considered to be fully charged and the charging is stopped; If the battery type is lithium battery, when the battery voltage is greater than or equal to the constant voltage charging value and the charging current is less than the set value, the battery is considered to be fully charged and the charging is stopped.
11	Battery Type	[11] USE	User-defined; all battery parameters can be set.
		[11] SLd	Sealed lead-acid battery; constant-voltage charge voltage: 57.6V, floating charge voltage: 55.2V.
		[11] FLd	Vented lead-acid battery; constant-voltage charge voltage: 58.4V, floating charge voltage: 55.2V.
		[11] GEL	Colloidal lead-acid battery; constant-voltage charge voltage: 56.8V, floating charge voltage: 55.2V.
		[11] LF14/LF15/LF16 (default)	Lithium iron phosphate battery LF14/LF15/LF16, corresponding to 14strings ,15 strings and 16 strings of lithium iron phosphate battery; for 16 strings, default constant-voltage charge voltage is 56.8V; for 15 strings, default constant-voltage charge voltage is 53.2V; for 14 strings, default constant-voltage charge voltage is 49.2V; allow adjustable.
		[11] N13/N14	Ternary lithium battery; which is adjustable. The default constant voltage charging voltage of N13 is 53.2V, and the default constant voltage charging voltage of N14 series is 57.6V.
12	Battery boost charge voltage	[12] 56.8V (default)	Boost charge voltage setting; the setting range is 48V~58.8V, with step of 0.1V; it is valid for user-defined battery and lithium battery.
13	Battery floating charge voltage	[13] 56.8V (default)	Floating charge voltage, setting range: 48V~58.8V, step: 0.1V.

Parameter no.	Parameter name	Settings	Description
14	Battery boost charge time	[14] 120 (default)	Boost charge maximum time setting, which means the maximum charging time to reach the set voltage of parameter [12] during constant-voltage charging. The setting range is 5min~900min, with a step of 5 minutes. It is valid for user-defined battery and lithium battery.
15	Battery recharge recovery point	[15] 53.6V (default)	After the battery is fully charged, the inverter stops charging, and restarts charging when the battery voltage is lower than the voltage value.
16	Battery Power to Utility Setpoint	[16] 49.2V (default)	When the parameter [01] =Bat, the battery voltage is lower than the set value, and the output is switched from the inverter to the mains. Setting range: 38V~57.2V.
17	Utility to Battery Power Setpoint	[17] 57.6V (default)	When the parameter [01] =Bat, the battery voltage is higher than the set value, and the output is switched from the mains to the inverter. Setting range: 48V~60V.
18	Battery under voltage alarm	[18] 49.6V (default)	Battery undervoltage alarm point; when the battery voltage is lower than the point, an undervoltage alarm is given (01 fault), and the output is not turned off; the setting range is 39V~56V, with a step of 0.1V.
19	Battery over discharge voltage (delay off)	[19] 48.8V (default)	Over-discharge voltage; when the battery voltage is lower than this judgment point, delay the time set by parameter [22] and turn off inverter output. Setting range is 38V~56V, with a step of 0.1V.
20	Battery over discharge voltage (immediately)	[20] 46.4V (default)	Battery discharge limit voltage; when the battery voltage is lower than the point, the output is turned off immediately (02 fault); the setting range is 38V~48.8V, with a step of 0.1V. It is valid for user-defined battery and lithium battery.
21	Battery voltage recovery point after over discharge protection (02 fault)	[21] 52.8V (default)	When the battery over discharge protection disconnects the inverter output, the battery voltage must be greater than this value to restore the inverter AC output.
22	Battery over discharge delay time	[22] 30S (default)	Over-discharge delay time; when the battery voltage is lower than the parameter [19] , the inverter output will be turned off after the time set

Parameter no.	Parameter name	Settings	Description
			by this parameter is delayed. The setting range is 5S~120S, with a step of 5S.
23	RS485-2 /BMS communication	[23] DIS (default)	RS485-2 Disable the BMS communication. However, our PC and remote monitoring protocol can continue to be used.
		[23] RS485	RS485-2 port for BMS communication.
24	BMS protocol Settings	When the setting Program [23] is RS485, the corresponding lithium battery manufacturer brand needs to be selected for communication	
		VOL=Voltronic、PLN=Pylon-V1.2、AOG=Aoguan、OLT=Oulite、GXU=Gotion、XWD=Sunwoda、CFE=CF、DAQ=Dyness、PCE=Pace、BST=BST、MIT=Foress、ACE=AEC、PL3=Pylon-V3.5、MeI=MeZic、TNT=Tentek.	
25	SOC discharge alarm (Optional when BMS is enabled)	[25] 15% (default)	After the BMS of the setting item [23] is enabled, the machine will alarm 07 if the battery capacity rate is lower than this value, and the alarm will be cleared if the battery capacity rate is higher than 5% of this value.
26	SOC switching mains (optional when BMS is enabled)	[26] 10% (default)	After the BMS of the setting item [23] is enabled, the machine will switch to the mains when the battery capacity rate is lower than this value and the mains power is available.
27	SOC switching inverter (optional when BMS is enabled)	[27] 100% (default)	After the BMS of the setting item [23] is enabled, it takes effect in battery priority mode. If the battery capacity rate is higher than this value, the machine will switch from the mains to the inverter mode.
28	SOC discharge cut off (optional when BMS is enabled)	[28] 5% (default)	After the BMS of the setting item [23] is enabled, if the battery capacity rate is lower than this value, the machine will report 08 fault and cut off the power supply or output.
29	SOC charging cut off (optional when BMS is enabled)	[29] 100% (default)	After the BMS of the setting item [23] is enabled, when the battery capacity rate is higher than this value, the inverter considers the battery to be full. If the battery priority mode is adopted at this time, the machine will switch the battery back from the mains.
30	Silent enablement of the buzzer	[30] DIS (default)	Alarm beep is enabled when the status of the main input source changes or the inverter fails.
		[30] ENA	Buzzer is silent

Parameter no.	Parameter name	Settings	Description
31	AC output mode (can be set in the standby mode only)	[31] SIG (default)	When single inverter is used, the default is SIG mode.
		[31] PAL	In parallel operation with single phase. Please refer to 8.3 Wiring Diagram.
		[31] 3P1/3P2/3P 3	In split phase operation with three phase. Please refer to 8.4 Wiring Diagram.
		All connected P1-phase inverters are set to " 3P1 "; All connected P2-phase inverters are set to " 3P2 "; All connected P3-phase inverters are set to " 3P3 "; When the parameter [02] setting item=230: AC output line voltage difference is 120 degrees (P1-P2/P1-P3/P2-P3), each line voltage is $230 \times 1.732 = 398\text{Vac}$; Each phase voltage is 230Vac (L1-N; L2-N; L3-N).	
32	RS485 ID setting	[32] 1 (default)	Parallel mode needs to be set in the range of 1-6, the ID cannot be repeated. When the power is first turned on, it will be automatically distributed. Single mode setting range 1-254.
33	Mixed mode (available for some models, Hybrid mode available)	[33] GID	Photovoltaic power generation has enough load power, and the excess is grid-connected power generation.
		[33] LOD (default)	Inverter power generation energy only to the load (generation power < Load power). Note: mixed load, mains and photovoltaic are loaded together, photovoltaic is not enough to supplement the mains.
		[33] CT	Anti-backflow, self-use according to the load power, do not input current to the mains.
34	N-PE connection switchover is enabled	[34] DIS (default)	Do not automatically connect the N wire to the PE wire under any working conditions.
		[34] ENA	When there is no mains input off the grid, the neutral line automatically connects to the PE. When the bypass has mains input, the neutral line is automatically disconnected from the PE.
35	Automatic battery activation	[35] DIS	When the battery is dormant or not connected, the PV or mains does not automatically activate the battery to turn on the battery output.
		[35] ENA (default)	When the battery is dormant or not connected, the PV or mains automatically activates the battery to turn on the battery output.

Parameter no.	Parameter name	Settings	Description
36	Grid-connected active power (Hybrid mode can be set)	[36] 0w	Active power that can be connected to the mains grid, setting range: 0w-8000w(8KW models)/ 0w-11000w(11KW models) / 0w-12000w(12KW models).
38	Mixed network priority enabling (Hybrid mode can be set)	[38] DIS (default)	The PV energy is preferentially used to charge the battery, and the excess energy is then generated to the grid.
		[38] ENA	The PV energy is given priority to the grid for power generation, and the excess energy is then used to charge the battery.
40	Battery pack connection setting	[40] DIS (default)	Parallel use of all battery packs.
		[40] ENA	Battery pack not connected in parallel. Each battery is connected to each inverter.
62	Overload auto-restart is enabled	[62] DIS	Overload automatic restart is prohibited. If overload shutdown output occurs, the machine will no longer start on.
		[62] ENA (default)	Enable overload automatic restart. If overload shutdown output occurs, the machine will restart the output after a delay of 3 minutes. After a total of 5 times in 30 minutes, the startup system is no longer resumed.
63	CT host Settings (The Hybrid mode can be set up)	[63] DIS (default)	
		[63] ENA	The anti-backflow host enables the inverter with CT connected when paralleling.
65	Charging Logic Setting (Optional when BMS is enabled)	[65]LNU (default)	BMS+Inverter,The maximum charging current of the battery is limited according to the descending logic of the machine.
		[65]BMS	BMS only,The maximum charging current of the battery is limited according to the current limit value of BMS.
		[65]SET	Manual setup,The maximum charging current of the battery is limited according to the set value of item [07].
66	Anti-backflow power compensation	[66]50W (default)	The power to be compensated is set according to the settings of the electricity meter, with a range of \pm 500.
67	Time of the second output when the battery is powered (valid	[67]OFF (default)	Close the second output.
		[67]FULL	The second output is always on.

Parameter no.	Parameter name	Settings	Description
	for some models and single-machine mode)	[67]5/890	Setting range: 5-890min.
68	When the battery is powered, turn off the second output circuit. Battery voltage point (valid for some models and single-machine mode)	[68]50V (default)	[23] After DIS is set, if the battery voltage is lower than this judgment point, the second output is cut off. The setting range is 40V~58V.
69	When the battery is powered, turn off the second output circuit. Battery SOC point (valid for some models and single-machine mode)	[69]20% (default)	[23] After the setting item BMS is enabled, if the battery capacity rate is lower than this value, the second output path is cut off.
70	Maximum discharge current of battery in mixed network mode	[70]	[01] When setting the HBD mode, it can limit the maximum discharge current of the battery.

5. Operating Mode Description

5.1. Charging mode

1) PV priority: PV module will charge the battery preferentially, and the battery is charged by the Mains only when the PV system fails. During the day, solar energy is fully used to charge, while at night, it converts to the Mains. This can maintain battery level, and is ideal for areas where the grid is relatively stable and electricity price is relatively high.

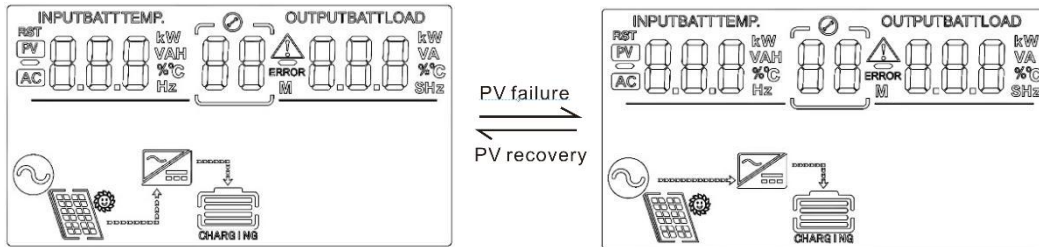

2) Mains priority: The Mains supply is preferentially used to charge the battery. Only when the Mains fails, the PV charging can be activated.

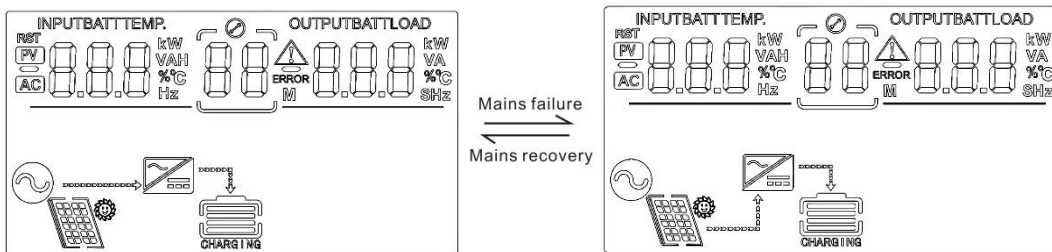

3) Hybrid charging: PV and mains hybrid charging. PV MPPT charging is a priority, and when PV energy is insufficient, the mains supply supplements. When the PV energy is sufficient again, the mains stops charging. This is the fastest charging mode, suitable for the areas where power grid is unstable, providing sufficient backup power supply at any time.

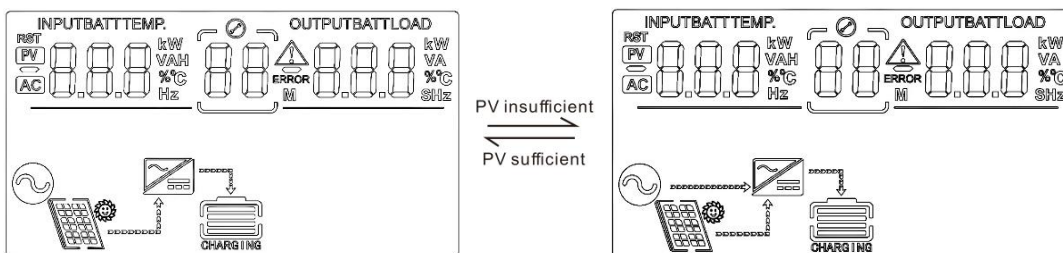

4) Only Solar Only Solar): Only PV charging, without Mains charging. This is the most energy-efficient way in which battery is charged only by solar panels, and is usually used in areas with good lighting conditions.

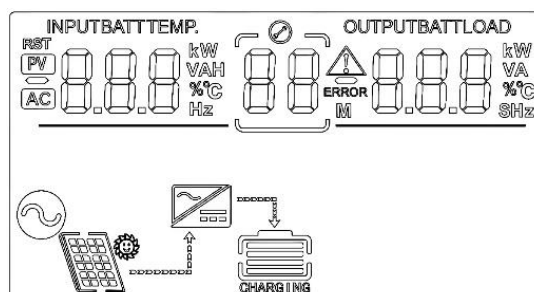

5.2、 Output mode

➤ PV priority mode:

Photovoltaics and batteries power the load, switch to mains supply when the PV charging fails. This mode maximizes the use of solar energy while maintaining battery power, suitable for use in the areas with relatively stable grid.

Power supply priority: Solar→Battery→Utility (PV recovery) .

Power supply priority: Solar→Utility→Battery (PV failure)

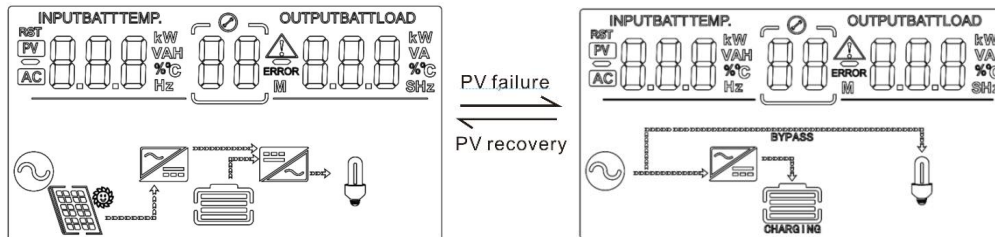

➤ Mains priority mode:

Switch to inverter only when the mains fails (when there was mains power, switch to mains power for charging and power supply). Then, the unit is equivalent to a backup UPS, suitable for areas with unstable grid. Switching does not affect PV charging.

Power supply priority: Utility→Solar→Battery.

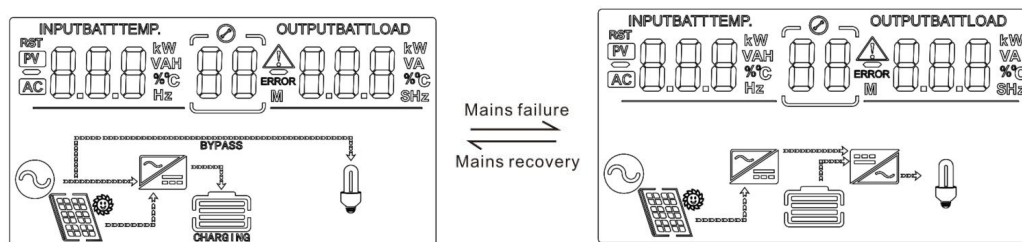

➤ Battery priority mode:

Switch to mains supply only when the battery discharge undervoltage is lower than the set point (item 16). When the charging battery is higher than the set point of (17 setting item), switch to the battery discharge mode. This can cycle the battery charge and discharge. This mode maximizes the use of DC power and is used in the area with stable grid. Switching does not affect PV charging.

Power supply priority: Solar→Battery→Utility.

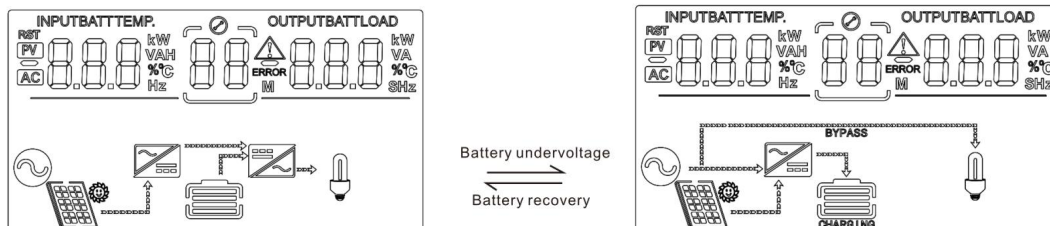

➤ Hybrid mode:

GID: Inverter power generation energy directly connected to the grid (generation power may be greater than the load power).

Note: photovoltaic power generation is sufficient load power, excess grid-connected power generation.

LOD: Inverter power generation energy only to the load (generation power less than Load power).

Note: Mixed load operation, the main power supply and the photovoltaic (PV) power generation system operate jointly, and the PV power generation system cannot independently supplement the main power supply.

CT: A current transformer (CT) is mandatory for this operational mode. The external CT will monitor the reverse power flow to the grid. Upon detection, it will regulate the inverter's output power to a level that solely caters to the local load demand, while also supporting battery charging and the power supply for home loads.

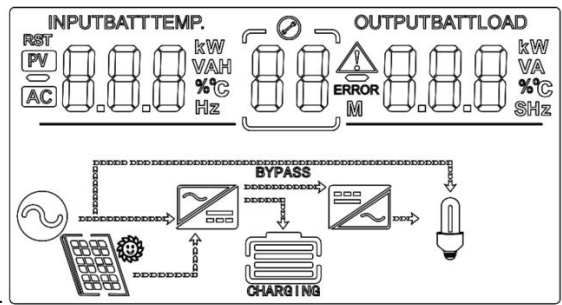

6. Battery type parameters

6.1. For Lead-acid Batteries

Battery Type parameter	Sealed lead acid battery (SLD)	Colloidal lead acid battery (GEL)	Vented lead acid battery (FLD)	User-defined (User)
Overvoltage disconnection voltage	60V	60V	60V	40 ~ 60V (Adjustable)
Battery fully charged recovery point(setup item 15)	52V (Adjustable)	52V (Adjustable)	52V (Adjustable)	52V (Adjustable)
Boost charge voltage	57.6V	56.8V	58.4V	40 ~ 60V (adjustable)
Floating charge voltage	55.2V	55.2V	55.2V	40 ~ 60V (adjustable)
Undervoltage alarm voltage(01 fault)	44V	44V	44V	40 ~ 60V (adjustable)
Undervoltage alarm voltage recovery point(01 fault)	Undervoltage alarm voltage+0.8V			
Low voltage disconnection voltage(02 fault)	42V	42V	42V	40 ~ 60V (Adjustable)
Low voltage disconnection voltage recovery point (02 fault)	52V (Adjustable)	52V (Adjustable)	52V (Adjustable)	52V (Adjustable)
Discharge limit voltage	40V	40V	40V	40 ~ 60V (Adjustable)
Over-discharge delay time	5s	5s	5s	1 ~ 30s (Adjustable)
Boost charge duration	120 minutes	120 minutes	120 minutes	10 ~ 600 minutes (Adjustable)

6.2、 For Lithium Batteries

Battery type Parameters	Ternary lithium battery (N13)	Ternary lithium battery (N14)	Lithium iron phosphate battery (LF16)	Lithium iron phosphate battery (LF15)	Lithium iron phosphate battery (LF14)
Overvoltage disconnection voltage	60V	60V	60V	60V	60V
Battery fully charged recovery point(setup item 15)	50.4V (Adjustable)	54.8V (Adjustable)	53.6V (Adjustable)	50.4V (Adjustable)	47.6V (Adjustable)
Boost charge voltage	53.2V (Adjustable)	57.6V (Adjustable)	56.8V (Adjustable)	53.2V (Adjustable)	49.2V (Adjustable)
Floating charge voltage	53.2V (Adjustable)	57.6V (Adjustable)	56.8V (Adjustable)	53.2V (Adjustable)	49.2 (Adjustable)
Undervoltage alarm voltage(01 fault)	43.6V (Adjustable)	46.8V (Adjustable)	49.6V (Adjustable)	46.4V (Adjustable)	43.2V (Adjustable)
Undervoltage alarm voltage recovery point(01 fault)	Undervoltage alarm voltage+0.8V				
Low voltage disconnection voltage(04 fault)	38.8V (Adjustable)	42V (Adjustable)	48.8V (Adjustable)	45.6V (Adjustable)	42V (Adjustable)
Low voltage disconnection voltage recovery point (04 fault)(setup item 35)	46V (Adjustable)	49.6V (Adjustable)	52.8V (Adjustable)	49.6V (Adjustable)	46V (Adjustable)
Discharge limit voltage	36.4V	39.2V	46.4V	43.6V	40.8V
Over-discharge delay time	30s (Adjustable)	30s (Adjustable)	30s (Adjustable)	30s (Adjustable)	30s (Adjustable)
Boost charge duration	120 minutes (Adjustable)	120 minutes (Adjustable)	120 minutes (Adjustable)	120 minutes (Adjustable)	120 minutes (Adjustable)

7. Communication

7.1. Overview

Inverter model: SPI4856V100-500/SPI4856V100-500P、SPI4862V100-500/SPI4862V100-500P

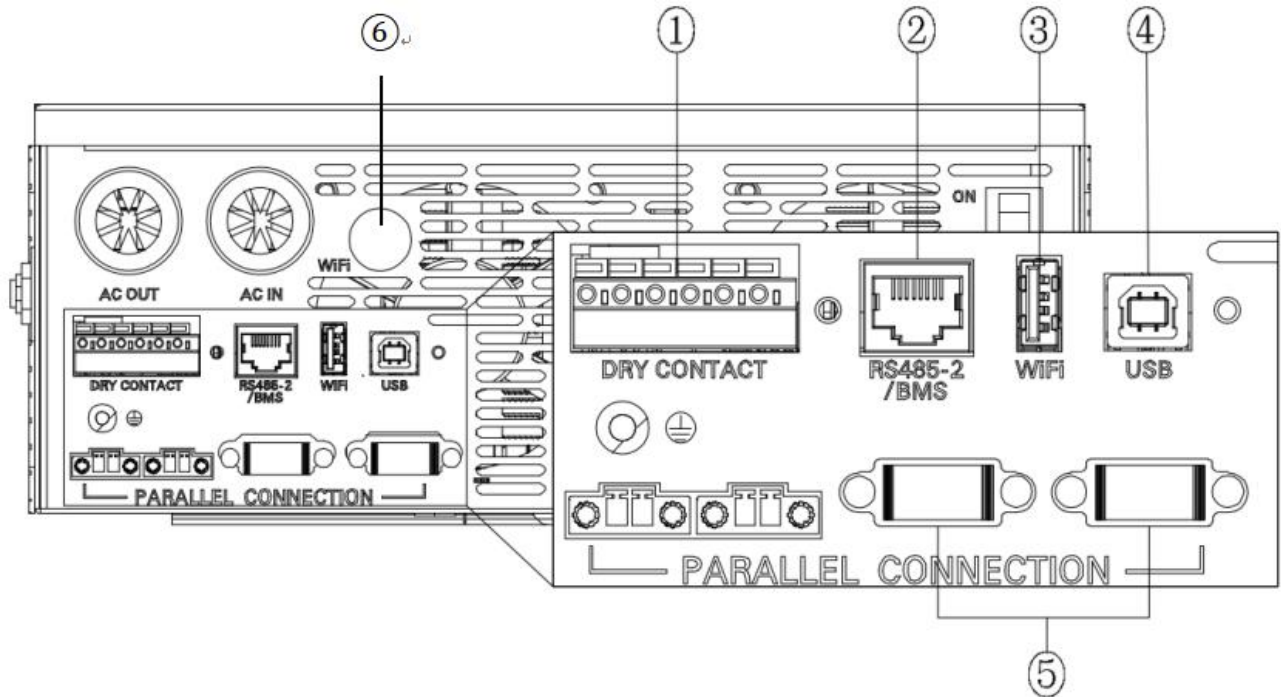

1	Dry contact port	2	RS485-2/BMS port	3	WIFI port
4	USB-B port	5	Parallel communication port		
6	WIFI port				

Inverter model: SPI4880V150-500/SPI4880V150-500P、SPI48110V150-500/SPI48110V150-500P、SPI48120V150-500/SPI48120V150-500P

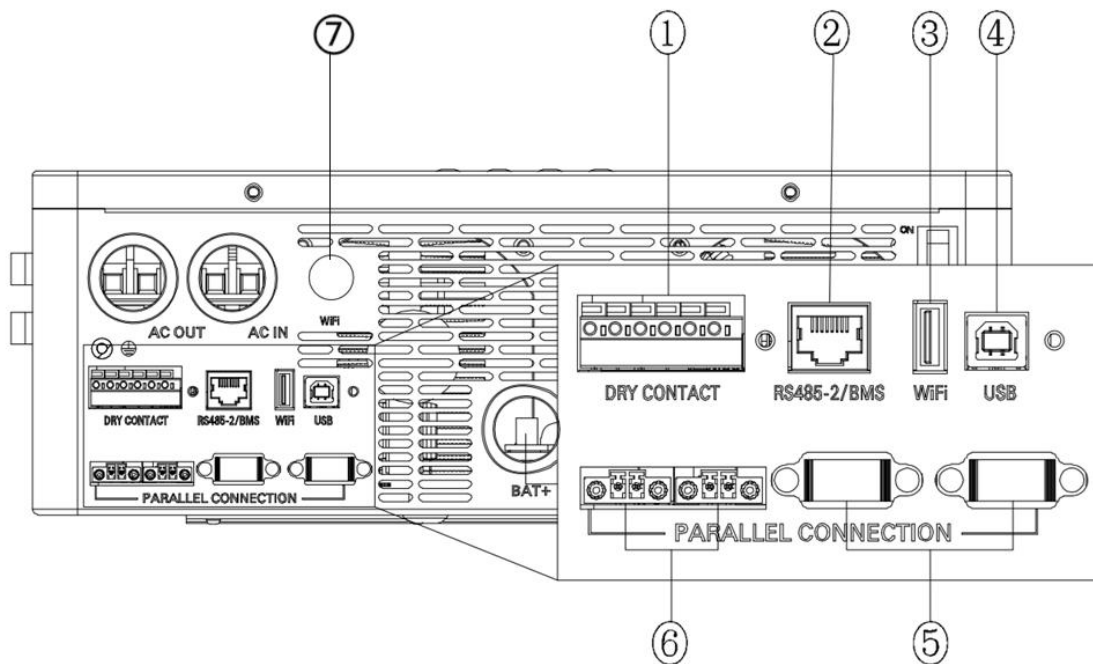

1	Dry contact port	2	RS485-2/BMS port	3	WIFI port
4	USB-B port	5	Parallel communication port	6	Current sharing port
7	WIFI port				

7.2、USB communication port

This is a USB communication port, which can be used for USB communication with the optional PC host software. To use this port, you should install the corresponding "USB to serial chip CH340T driver" in the computer.

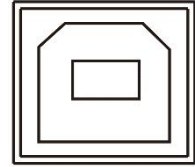

7.3、WIFI communication port

There are two WIFI ports, namely USB Type-A port and socket (XH2.54_4P). The specific connection and related instructions are as follows: (Note: the upper computer and WIFI module cannot be used at the same time).

1. The USB Type-A port can be directly connected to the RS485 to WIFI/GPRS communication module with USB Type-A interface.

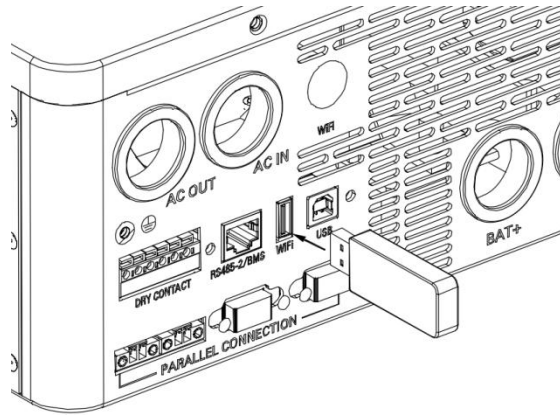

2. The socket (XH2.54_4P) must be connected to the RS485-to-WIFI/GPRS communication module with an aviation waterproof connector via a "XH2.54_4P plug adapter for aviation waterproof connector and WIFI cable".

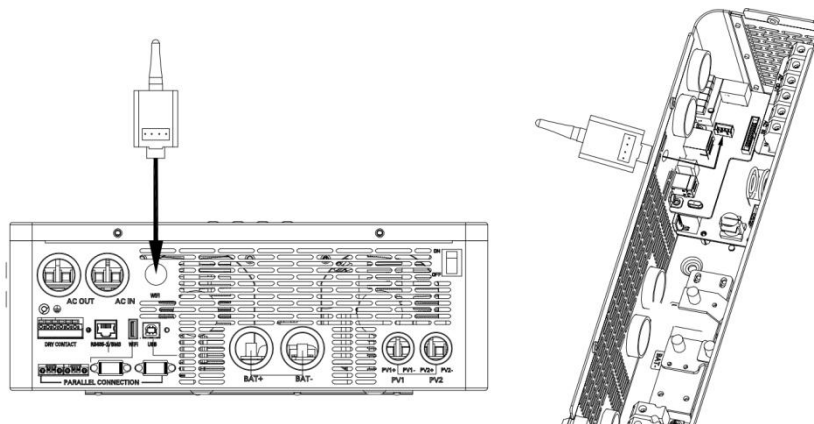

7.4、RS485 communication port

This port is an RS485 communication port. When the BMS is enabled, it can communicate with the lithium battery BMS via RS485.

As shown in the figure:

RS485-2: Pin 1 is RS485-B, Pin 2 is RS485-A, Pin 4 is CAN-L, and Pin 5 is CAN-H, Pin 7 is RS485-A, Pin 8 is RS485-B;

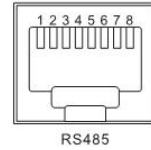

7.5、Dry contact port

N - NO - NC function:

Working principle: This dry node can control the ON/OFF of the diesel generator.

1) Normally, NC-N point is connected and the NO-N point is disconnected;

2) When the battery voltage reaches the low voltage disconnection point, the relay coil is energized, the NO-N point is connected while NC-N point is disconnected. At this point, NO-N point can drive resistive loads specifications: 125VAC/1A, 230VAC/1A or 30VDC/1A.

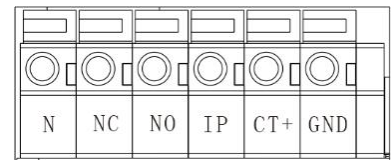

IP - GND function:

Optional function, not standard function;

Working principle: This dry node can control the AC output power ON/OFF of the inverter.

1) IP - GND is disconnected → AC output ON;

2) IP - GND is connected → AC output OFF;

(CT+) - GND function:

Optional function, not standard function;

Working principle: By sampling the input line current, self-use function is realized. But need to use our configuration of CT sensors;

7.6、Parallel communication function (parallel operation only)

- a) This port is used for parallel communication, through which the parallel modules can communicate with each other.
- b) Each inverter has two DB15 ports, one for the male connector and the other for the female connector.
- c) When connecting, make sure to connect the male connector of the inverter with the female connector of the inverter to be paralleled, or connect the female connector of the inverter to the male connector of the inverter to be paralleled.
- d) Do not connect the male connector of the inverter to its female connector.

Female connector

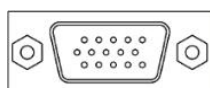

Male connector

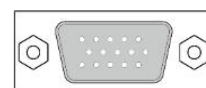

7.7、Current sharing detection function (parallel operation only)

- a) This port is used for current sharing detection, through which the current sharing of the parallel modules can be detected (parallel operation only).
- b) Each inverter has two current sharing detection ports, which are connected in parallel. When it is connected to other models to be paralleled, either port can be connected for convenience. There is no special mandatory wiring requirements.



8. Parallel installation and wiring

8.1. Introduction

- 1、 Maximum six inverters can be used for parallel operation. **Only “-500P” models can support parallel.**
- 2、 When using the parallel operation function, the following connecting lines (package accessories) shall be firmly and reliably connected:

Parallel communication line*1:



Current sharing detection line*1:



8.2. Precautions for connecting the parallel connecting lines

Warning: 

1. Battery wiring:

Parallel connection in single or split phase: Ensure that all all-in-one solar charger inverters are connected to the same battery, with BAT + connected to BAT + , BAT - connected to BAT -, and that the connection is correct with the same wiring length and line diameter before power on and start-up, so as to avoid the abnormal operation of parallel system output caused by wrong connection.

2. AC OUT wiring:

Parallel connection in single phase: Ensure L-to-L, N-to-N and PE-to-PE connection for all all-in-one solar charger inverters, and that the connection is correct with the same wiring length and line diameter before power on and start-up, so as to avoid the abnormal operation of parallel system output caused by wrong connection. For specific wiring, please refer to 8.3 Wiring Diagram

Parallel connection in split phase: Ensure N-to-N and PE-to-PE connection for all all-in-one solar charger inverters. The **L** lines of all inverters connected to the same phase need to be connected together. But **L** lines of different phases cannot be joined together. Other connection precautions are the same as parallel connection in single phase. For specific wiring, please refer to 8.4 Wiring Diagram

3. AC IN wiring:

Parallel connection in single phase: Ensure L-to-L, N-to-N and PE-to-PE connection for all all-in-one solar charger inverters, and that the connection is correct with the same wiring length and line diameter before power on and start-up, so as to avoid the abnormal operation of parallel system output caused by wrong connection. Meanwhile, it is not allowed to have multiple different AC source inputs to avoid damage to the external equipment of the inverter. The consistency and uniqueness of AC source input shall be ensured. For specific wiring, please refer to 8.3 Wiring Diagram.

Parallel connection in split phase: Ensure N-to-N and PE-to-PE connection for all all-in-one solar charger inverters. The **L** lines of all inverters connected to the same phase need to be connected

together. But **L** lines of different phases cannot be joined together. Other connection precautions are the same as parallel connection in single phase. For specific wiring, please refer to 8.4 Wiring Diagram.

4. **Wiring of parallel communication line:**

Parallel connection in single or split phase: Our company's parallel communication line is a DB15 standard computer cable with shielding function. Ensure the "one-in-one-out" rule when connecting each inverter, that is, connect the male connector (out) of this inverter with the female connector (in) of the inverter to be paralleled. Do not connect the male connector of the inverter to its female connector. In addition, make sure to tighten the parallel communication line of each inverter with self-contained end screws of DB15 to avoid the abnormal operation or damage of the system output caused by the falling off or poor contact of the parallel communication line.

5. **Wiring of current sharing detection line:**

Parallel connection in single phase: Our company's current sharing detection line is a twisted connection line. Ensure the "one-in-one-out" rule when connecting each inverter, that is, connect the current sharing line of the inverter with the current sharing green port of the inverter to be paralleled (choose one port from the two, and there is no mandatory sequence requirement). The current sharing ports of the inverter cannot be connected to each other. In addition, make sure that the red and black current sharing connection lines of each inverter are not manually exchanged, and make sure to tighten the lines with self-contained screws to avoid the abnormal operation or damage of the system output caused by abnormal parallel current sharing detection. For specific wiring, please refer to 8.3 Wiring Diagram.

Parallel connection in split phase: The current sharing detection lines of all inverters connected to the same phase need to be connected together. But the current sharing detection lines of different phases cannot be joined together. Other connection precautions are the same as parallel connection in single phase. For specific wiring, please refer to 8.4 Wiring Diagram.

6. Before or after connecting the system, please carefully refer to the following system wiring diagram to ensure that all wiring is correct and reliable before power on.
7. After the system is wired, powered on and in normal operation, if a new inverter needs to be connected, make sure to disconnect the battery input, PV input, AC input and AC output, and that all all-in-one solar charger inverters are powered off before reconnecting into the system.

8.3. **Schematic diagram of parallel connection in single phase**

1. The parallel communication line and current sharing detection line of the all-in-one solar charger inverter need to be locked with screws after connecting. The schematic diagram is as follows:

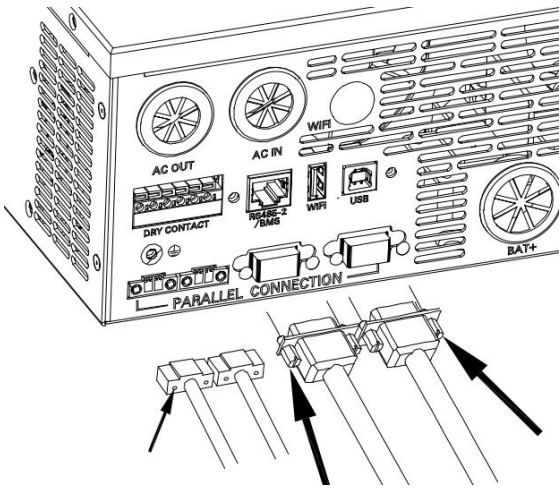

SPI4856V100-500/SPI4856V100-500P
 SPI4862V100-500/SPI4862V100-500P

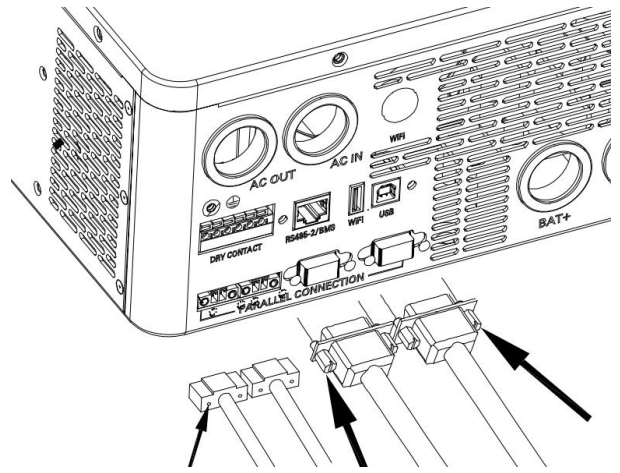

SPI4880V150-500/SPI4880V150-500P
 SPI48110V150-500/SPI48110V150-500P
 SPI48120V150-500/SPI48120V150-500P

2. In case of parallel operation with multiple inverters, the schematic diagram of parallel connection is as follows:

a) Two all-in-one solar charger inverters of the system connected in parallel:

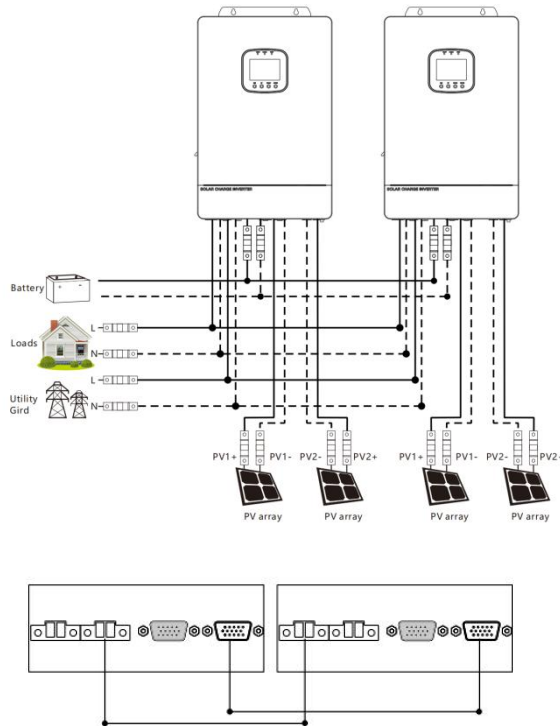

b) Three all-in-one solar charger inverters of the system connected in parallel:

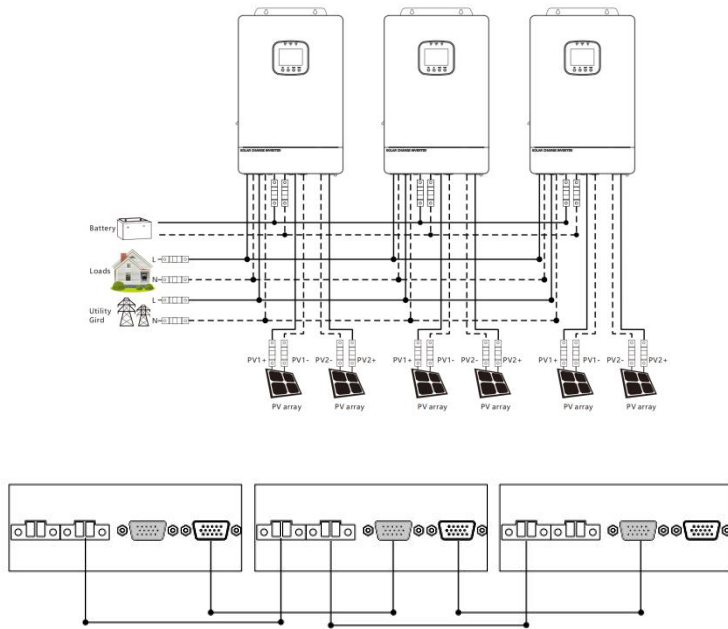

c) Four all-in-one solar charger inverters of the system connected in parallel:

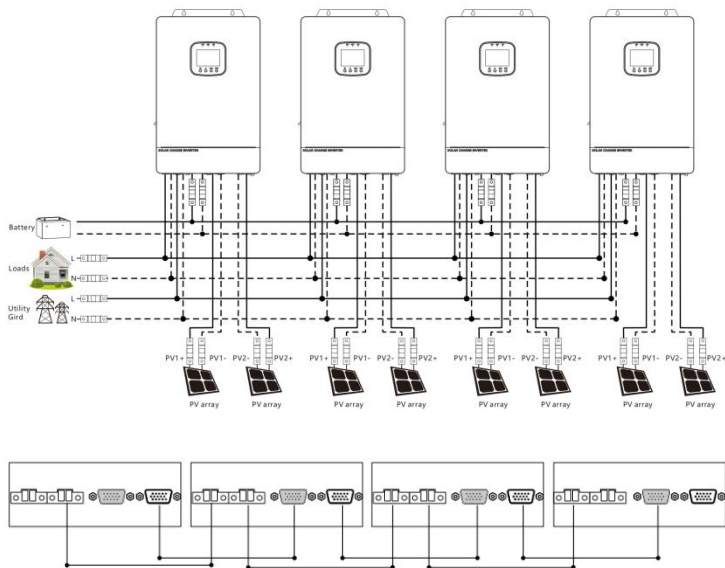

d) Five all-in-one solar charger inverters of the system connected in parallel:

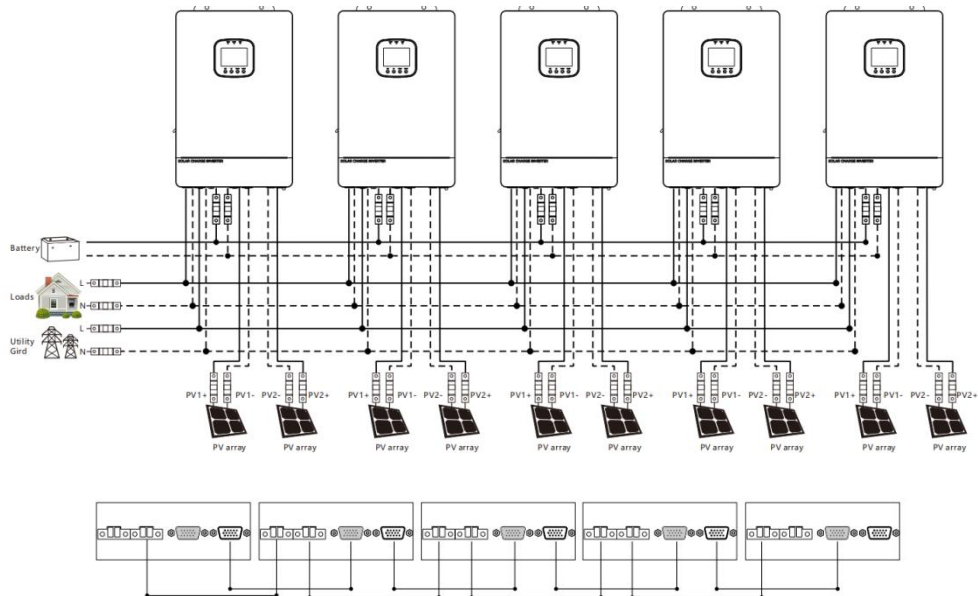

e) Six all-in-one solar charger inverters of the system connected in parallel:

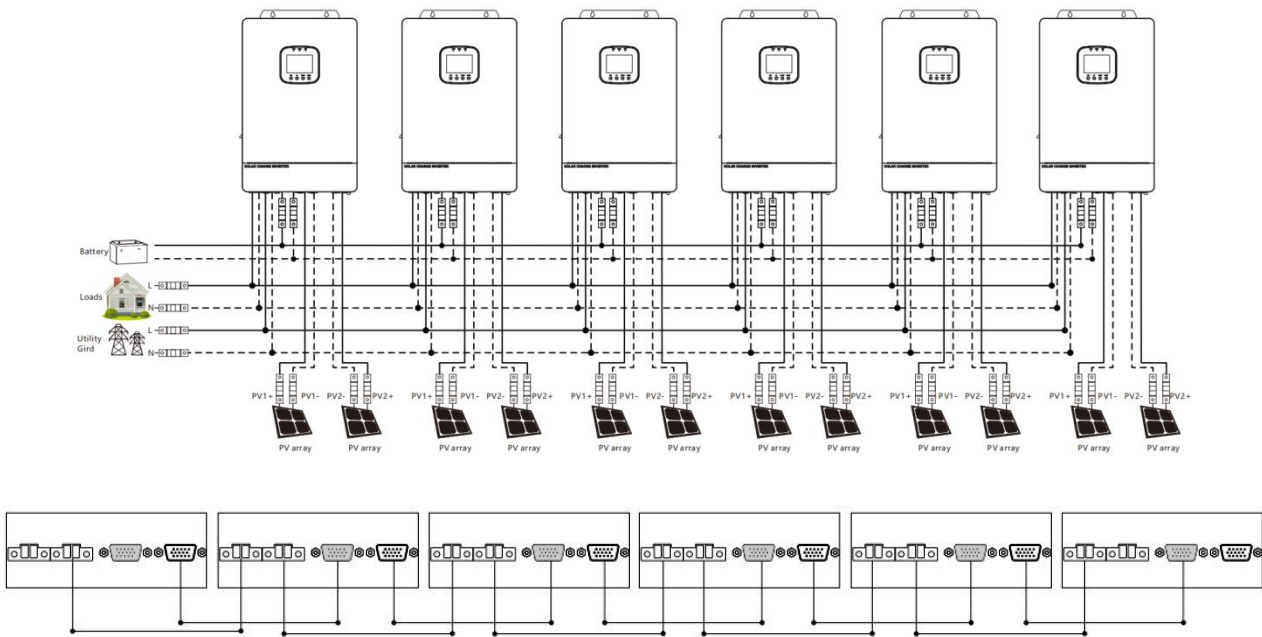

8.4. Schematic diagram of parallel connection in split phase

In case of parallel operation with multiple inverters, the schematic diagram of parallel connection is as follows:

Parallel Operation in three phase:

a) Three all-in-one solar charger inverters of the system connected in three phase:

1+1+1 system:

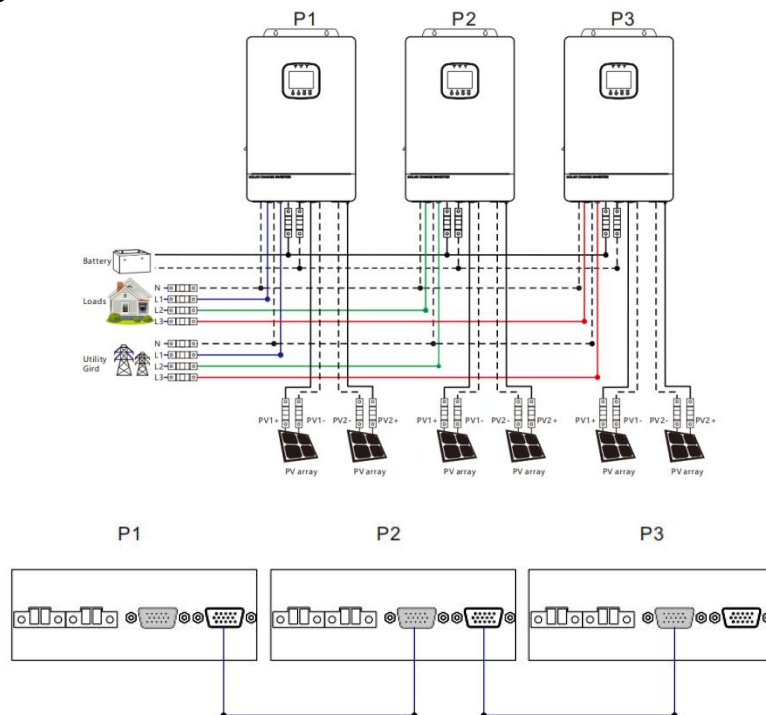

b) Four all-in-one solar charger inverters of the system connected in three phase:

2+1+1 system:

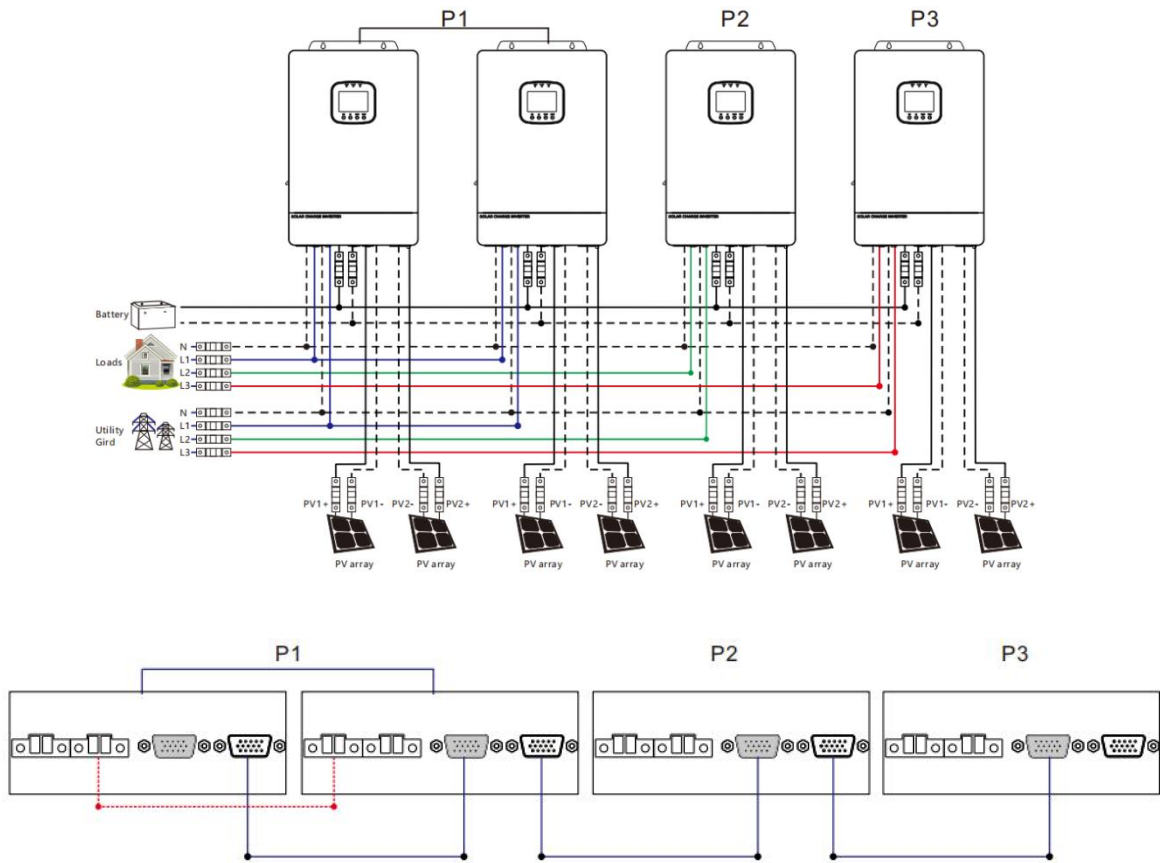

c) Five all-in-one solar charger inverters of the system connected in three phase:

2+2+1 system:

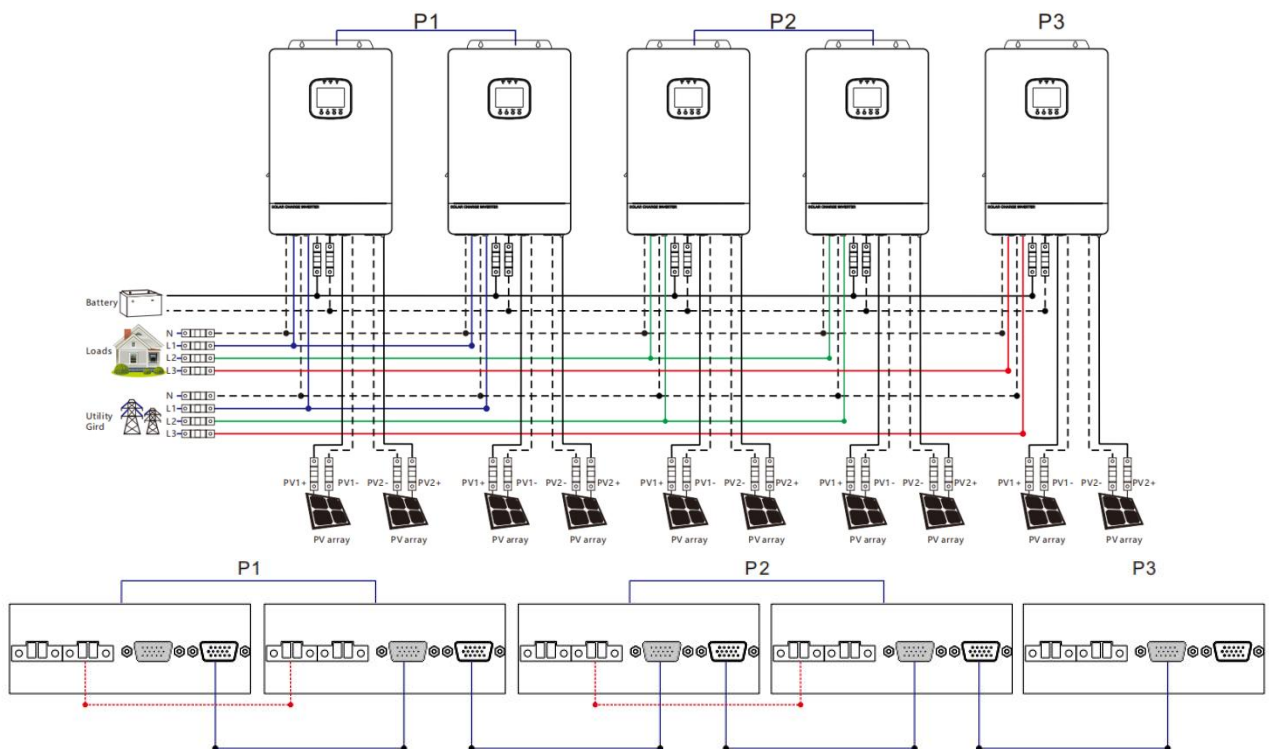

3+1+1 system:

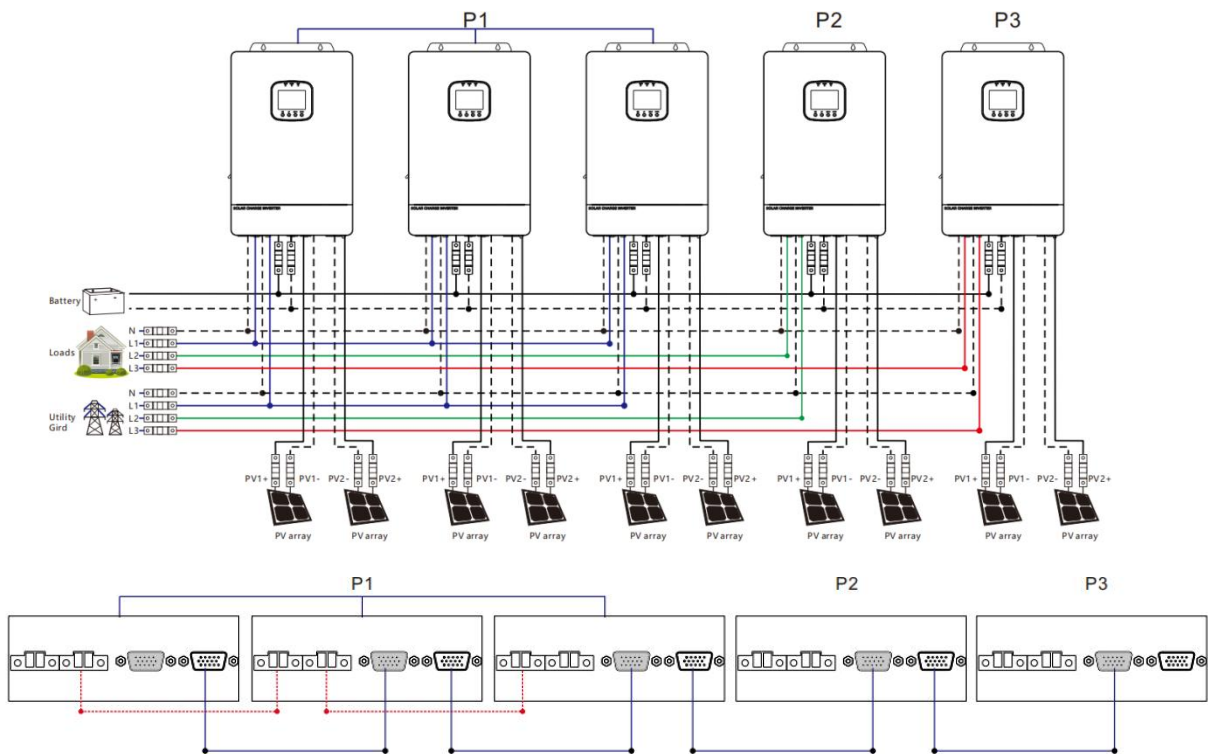

d) Six all-in-one solar charger inverters of the system connected in three phase:

2+2+2 system:

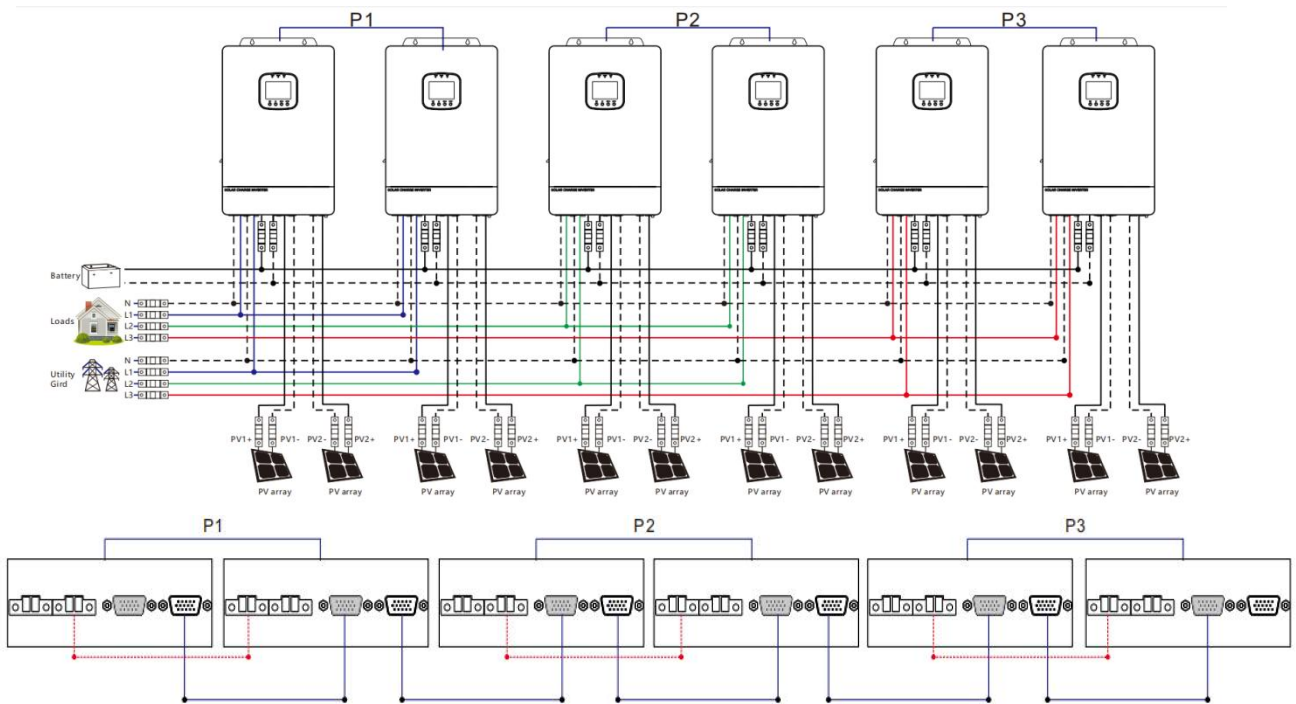

3+2+1 system:

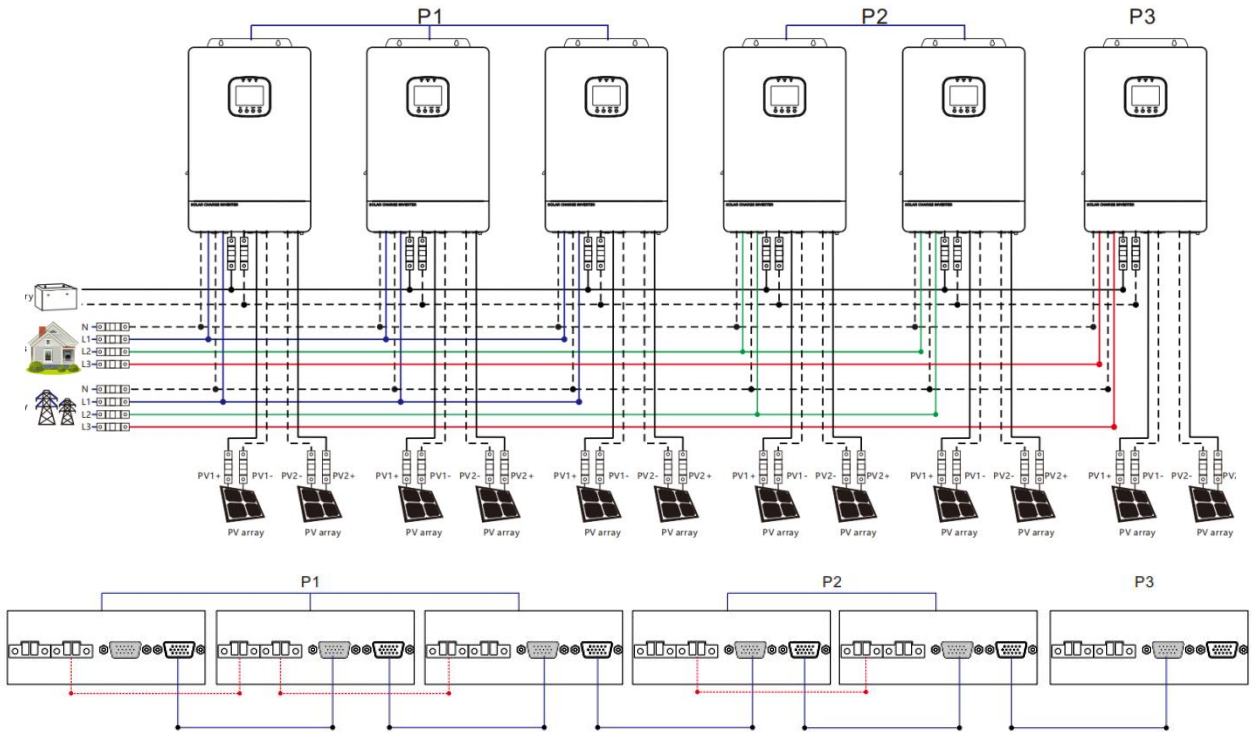

4+1+1 system:

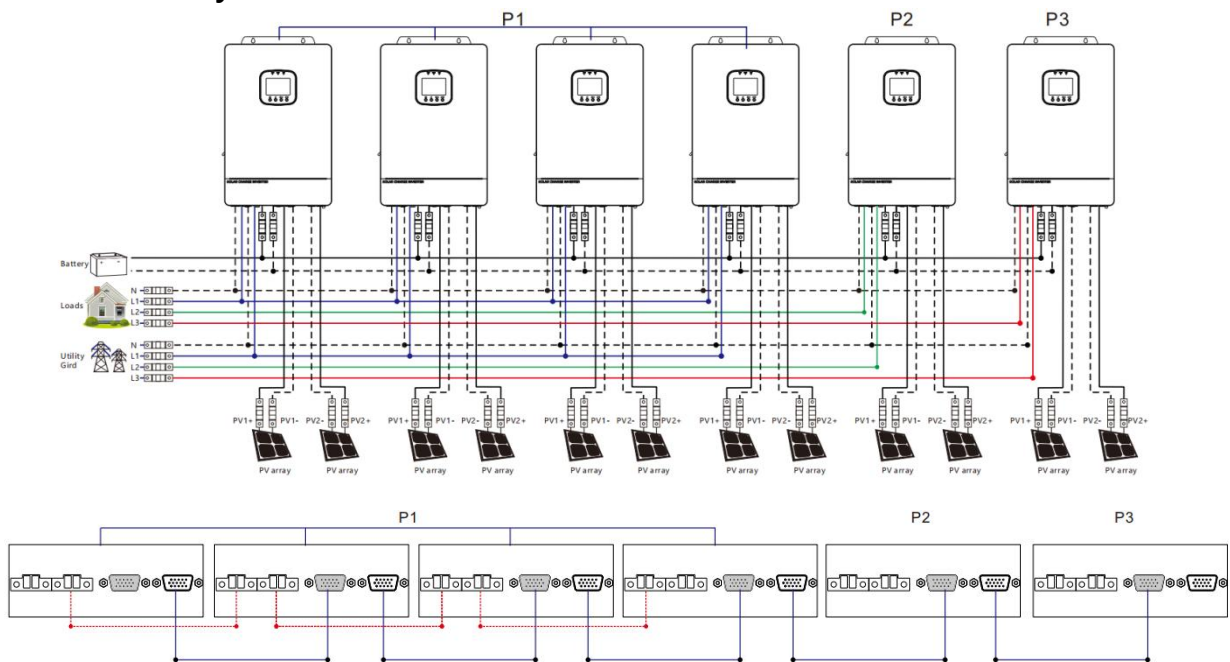

Note:

- 1) Before starting up and running, please check whether the connection was correct to avoid any abnormalities in the system
- 2) All wiring must be fixed and reliable to avoid wire drop during use.
- 3) When the AC output is wired to the load, it shall be properly wired according to the requirements of the electrical load equipment to avoid damage to the load equipment
- 4) Settings **[02]** need to be set consistently or only for the host. When the machine is running, the voltage set by the host shall prevail, and the master will force the rewrite of the other slave machines to keep the same set. Only can be set in the standby mode.
- 5) When using parallel or split phase separation function, the **[31]** setting items need to be set accordingly.

- 6) When the phase sequence is set **[02] [31]** on the screen, the setting one is turned on to set, and the other machines are turned off. One by one set. Finally, power off and start up again.
- 7) After the system runs, the output voltage is measured correctly, and then the load setting is connected

9. Failure codes and countermeasures

9.1、 Fault code

Fault code	Fault name	Whether it affects the output or not	Description
【01】	Battery under voltage warning	No	If the battery voltage is lower than 【18】 , the battery is in the undervoltage state.
【02】	Battery under voltage protection	Yes	When the battery voltage is low, turn off the output to stop the battery discharge protection.
【03】	Average battery discharge current over current protection	Yes	If the average battery discharge current exceeds the maximum input battery current for 1 minute, turn off the output to stop the battery discharge protection.
【04】	Instantaneous battery discharge over current protection	Yes	If the instantaneous value of the battery discharge current is greater than the maximum instantaneous value of the device, turn off the output to stop the battery discharge protection.
【05】	Battery not connected	Yes	Battery not connected warning.
【06】	Battery over voltage	Yes	When the selected battery type or set battery voltage is exceeded, turn off the output to stop the battery charging protection.
【07】	BMS low battery alarm	No	BMS alarm low battery (Set BMS enablement to work)
【08】	BMS low battery protection	Yes	The BMS battery capacity rate is low. Disable the output to stop the battery discharge protection. (Set BMS enablement to work)
【09】	Bypass overload protection	Yes	If the mains is overloaded, turn off the AC output and stop the mains charging.
【10】	Battery output overload protection	Yes	If the battery discharge inverter is overloaded, turn off AC output and stop battery discharge protection.
【11】	Battery inverter output short circuit	Yes	If the AC output of the battery inverter discharge is short circuiting, turn off the AC output and stop the battery

			discharge protection.
【12】	The AC output of the battery inverter overcurrent	Yes	If the AC output of the battery inverter discharge is overcurrent, turn off the AC output and stop the battery discharge protection.
【13】	The DC component of the battery inverter voltage is abnormal	Yes	If the DC component of the battery inverter voltage is abnormal, turn off the AC output and stop the battery discharge protection.
【14】	Bus over voltage hardware sampling protection	Yes	Internal battery boost, boost bus voltage overvoltage hardware protection, turn off AC output and charge.
【15】	Bus over voltage software sampling protection	Yes	Internal battery boost, boost bus voltage overvoltage software protection, turn off AC output output and charge.
【16】	Bus under voltage protection	Yes	Internal battery boost, boost bus voltage undervoltage protection, turn off AC output output and charge.
【17】	Bus short circuit protection	Yes	Internal battery boost, boost bus voltage short-circuit protection, turn off AC output output and charge.
【18】	The PV input voltage is over voltage	Yes	The solar input voltage exceeds the maximum allowable input voltage protection.
【19】	The PV current software is overcurrent	-	-
【20】	PV over current protection	No	Solar charging overcurrent hardware protection, turn off solar charging.
【21】	The PV insulation impedance is low	-	-
【22】	The PV heat sink is overheated. Procedure	No	If the temperature of the solar charging radiator is too high, turn off the solar charging.
【23】	The AC heat sink is overheated. Procedure	Yes	If the temperature of the heat sink is too high, turn off the AC charging or battery inverter discharge.
【24】	The temperature of the main transformer is overheated	Yes	If the internal main transformer temperature is too high, turn off the AC charging or battery inverter discharge.
【25】	Ac input relay short	Yes	Ac input relay short-circuit protection

	circuit		prevents the inverter AC output from being pumped back into the bypass AC input.
【26】	The AC output relay is short-circuit	Yes	AC output relay short circuit protection, turn off the inverter output and all charging functions.
【27】	Fan failure	Yes	If the fan is blocked or fails, disable the inverter output and charging functions.
【28】	EEPROM hitch	-	-
【29】	SPI Communication failure	-	-
【30】	Type detection error	Yes	The model is not set before delivery, and the model identification is wrong.
【31】	The bus fails to soft	-	-
【32】	The leakage current is abnormal	-	-
【33】	Parallel control CAN communication is faulty	Yes	In parallel mode, CAN communication is lost, AC output and charging are turned off.
【34】	communication CAN communication is faulty	Yes	In parallel mode, CAN communication is lost, AC output and charging are turned off.
【35】	Parallel mode is faulty	Yes	In parallel mode, the system has inconsistent machine parallel mode 【31】 Settings.
【36】	Parallel current sharing fault	Yes	In parallel mode, the AC output of the battery inverter differs greatly from the non-uniform current output of each machine. Turn off the AC output and charge.
【37】	Parallel ID setting error	Yes	In parallel mode, the RS485 addresses repeatedly conflict. The fault stops the AC output and charge. After the host automatically reallocates the address, the fault is cleared and the host enters the parallel.
【38】	Inconsistent Battery in parallel mode	Yes	In parallel mode, the battery voltage input of each machine varies greatly.
【39】	Inconsistent AC input source in parallel mode	Yes	Parallel mode, inconsistent mains power input source.
【40】	The parallel mode synchronization	Yes	Parallel mode, hardware synchronization signal reception failure, stop parallel

	fails		and AC output.
【41】	Inconsistent system firmware version in parallel mode	Yes	If the program version is inconsistent in the parallel system, stop the parallel and AC output.
【42】	The parallel communication cable is faulty	Yes	The parallel communication line is faulty. Stop the parallel and AC output.
【43】	Serial number error	Yes	The serial number is not set before the factory, or the factory serial number is set repeatedly in the system.
【44】	Batt cap not enough	Yes	In the parallel system, one of the devices has a low battery voltage.
【45】	Aux dsp abnormal	Yes	Auxiliary DSP chip malfunction
【46】	Bus unbalance	Yes	In the split-phase inverter, the voltages of the positive bus and the negative bus are inconsistent.
【47】	Ext CT host err	No	In the parallel inverter system, Setting Item 【63】 is incorrectly configured. Only one inverter per phase can be designated as the external CT master.
【48】	Mains phase Err	No	Conduct a check on the phase of the utility power.
【49】	BMS communication error	No	Check whether the communication line is connected correctly and whether [11] is set to the corresponding lithium battery communication protocol
【50】	BMS other alarm	No	Check the BMS fault type and troubleshoot lithium battery problems
【51】	BMS battery over temperature alarm	No	BMS alarm lithium battery over temperature
【52】	BMS battery over current alarm	No	BMS alarm lithium battery over current
【53】	BMS battery over voltage alarm	No	BMS alarm lithium battery over voltage
【54】	BMS battery low voltage alarm	No	BMS alarm lithium battery low voltage
【55】	BMS battery low temperature alarm	No	BMS alarm lithium battery low temperature

9.2、 Trouble Shooting

Fault code	Faults	Handling measures
-------------------	---------------	--------------------------

/	No display on the screen	Check if the battery air switch or the PV air switch has been closed; if the switch is in the "ON" state; press any button on the screen to exit the screen sleep mode.
【06】	Battery overvoltage protection	Measure if the battery voltage exceeds rated. If it exceeds, the battery needs to be discharged until the voltage is below the overvoltage recovery point of the battery.
【01】 【02】	Battery under voltage protection	Charge the battery until it returns to the low voltage disconnection recovery voltage.
【27】	Fan failure	Check if the fan is not turning or blocked by foreign objects.
【22】 【23】	Heat sink over temperature protection	When the temperature of the device is cooled below the recovery temperature, normal charge and discharge control is resumed.
【09】 【10】	Bypass overload protection, inverter overload protection	1.Reduce the use of power equipment; 2.Restart the unit to resume load output.
【11】	Inverter short circuit protection	1.Check the load connection carefully and clear the short-circuit fault points; 2.Re-power up to resume load output.
【18】	PV overvoltage	Use a multimeter to check if the PV input voltage exceeds the maximum allowable input voltage rated.
【05】	Battery missing alarm	Check if the battery is not connected or if the battery circuit breaker is not closed.
【40】 【42】	Parallel connection fault	Check whether the parallel line is not connected well, such as loose or wrong connection.
【37】	Parallel ID setting error	Check whether the setting of parallel ID number is repeated.
【36】	Parallel current sharing fault	Check whether the parallel current sharing line is not connected well, such as loose or wrong connection.
【39】	Inconsistent AC input source in parallel mode	Check if the mains input of the parallel machine is the same input interface. If two machines in the three-phase group mode report inconsistent mains input sources, you can try swapping the mains input wiring of any two machines to check if the fault is caused by inconsistent mains input phase sequence and set phase sequence
【41】	Inconsistent system firmware version in parallel mode	Check whether the software version of each inverter is consistent.
【47】	The external CT host is set incorrectly	63 The setting is only enabled for the inverter connected to CT when the machine is connected.
【49】	A BMS	Check whether the BMS communication line and the

	communication error	inverter communication ports are correctly connected
--	---------------------	--

Note: If you encounter a product fault that cannot be solved by the methods in the above table, please contact our after-sales service department for technical support, and do not disassemble the equipment yourself.

10. Protection and Maintenance

10.1. Protections provided

No.	Protections	Description
1	PV current/power limiting protection	When charging current or power of the PV array configured exceeds the PV rated, it will charge at the rated.
2	PV night reverse-current protection	At night, the battery is prevented from discharging through the PV module because the battery voltage is greater than the voltage of PV module.
3	Mains input over voltage protection	When the mains voltage exceeds 280V (230V model), the mains charging will be stopped and switched to the inverter mode.
4	Mains input under voltage protection	When the mains voltage is lower than 170V (230V model /UPS mode) or 90V (APL mode), the mains charging will be stopped and switched to the inverter mode.
5	Battery over voltage protection	When the battery voltage reaches the overvoltage disconnection point, the PV and the mains will be automatically stopped to charge the battery to prevent the battery from being overcharged and damaged.
6	Battery low voltage protection	When the battery voltage reaches the low voltage disconnection point, the battery discharging will be automatically stopped to prevent the battery from being over-discharged and damaged.
7	Load output short circuit protection	When a short circuit fault occurs at the load output terminal for more than 200 milliseconds, the AC output is immediately turned off.
8	Heat sink over temperature protection	When the internal temperature is too high, the all-in-one machine will stop charging and discharging; when the temperature returns to normal, charging and discharging will resume.
9	Overload protection	Output again 3 minutes after an overload protection, and turn the output off after 5 consecutive times of overload protection until the machine is re-powered. For the specific overload level and duration, refer to the technical parameters table in the manual.
10	PV reverse polarity protection	When the PV polarity is reversed, the machine will not be damaged.
11	AC reverse protection	Prevent battery inverter AC current from being reversely input to Bypass.
12	Bypass over current protection	Built-in AC input overcurrent protection circuit breaker.

13	Battery input over current protection	When the discharge output current of the battery is greater than the maximum value and lasts for 1 minute, the AC input would switched to load.
14	Battery input protection	When the battery is reversely connected or the inverter is short-circuited, the battery input fuse in the inverter will blow out to prevent the battery from being damaged or causing a fire.
15	Charge short protection	When the external battery port is short-circuited in the PV or AC charging state, the inverter will protect and stop the output current.
16	CAN communication loss protection	In parallel operation, an alarm will be given when CAN communication is lost.
17	Parallel connection error protection	In parallel operation, the equipment will be protected when the parallel line is lost.
18	Parallel battery voltage difference protection	In parallel operation, the equipment will be protected when the battery connection is inconsistent and the battery voltage is greatly different from that detected by the host.
19	Parallel AC voltage difference protection	In parallel operation, the equipment will be protected when the AC IN input connection is inconsistent.
20	Parallel current sharing fault protection	In parallel operation, the running equipment will be protected when the load difference of each inverter is large due to improper connection of current sharing line or device damage.
21	Synchronization signal fault protection	The equipment will be protected when there is a fault in the guidance signal between parallel buses, causing inconsistent behavior of each inverter.

10.2、 Maintenance

In order to maintain the best long-term performance, it is recommended to conduct the following checks twice a year.

1. Make sure that the airflow around the unit is not blocked and remove any dirt or debris from the heat sink.
2. Check that all exposed wires are damaged by exposure to sunlight, friction with other objects around them, dryness, bite by insects or rodents, etc., and the wires shall be repaired or replaced if necessary.
3. Verify for the consistency of indication and display with the operation of the device. Please pay attention to the display of any faults or errors, and take corrective actions if necessary.
4. Check all wiring terminals for corrosion, insulation damage, signs of high temperature or burning/discoloration, and tighten the screws.
5. Check for dirt, nesting insects and corrosion, and clean up as required.
6. If the arrester has failed, replace it in a timely manner to prevent lightning damage to the unit and even other equipment of the user.

The company does not assume any liability for damage caused by:



NOTICE

- a) Improper use or use in improper location.
- b) Open circuit voltage of the PV module exceeds the maximum allowable voltage rated.
- c) Temperature in the operating environment exceeds the limited operating temperature range.
- d) Disassemble and repair the all-in-one solar charge inverter without permission.
- e) Force majeure: Damage that occurs in transportation or handling of the all-in-one solar charge inverter.



DANGER

Danger of electric shock! When doing the above operations, make sure that all power supplies of the all-in-one machine have been disconnected, and all capacitors have been discharged, and then check or operate accordingly!

11. Technical parameters

Models	SPI4856V100-500/ SPI4856V100-500P	SPI4862V100-500/ SPI4862V100-500P
Parallel mode		
Permitted parallel number	NO/1~6	
AC mode		
Rated input voltage	220/230Vac	
Input voltage range	(170Vac~280Vac) \pm 2%@UPS (90Vac-280Vac) \pm 2%@APL	
Frequency	50Hz/60Hz (Auto detection)	
Frequency Range	47 \pm 0.3Hz~55 \pm 0.3Hz (50Hz); 57 \pm 0.3Hz~65 \pm 0.3Hz (60Hz);	
Overload/short-circuit protection	Circuit breaker	
Maximum charging efficiency	>93%	
Conversion time (bypass and inverter)	10ms (typical)	
AC reverse protection	Yes	
Maximum bypass overload current	40A	
Inverter mode		
Output voltage waveform	Pure sine wave	
Rated output power (VA)	5600	6200
Rated output power (W)	5600	6200
Power factor	1	
Rated output voltage (Vac)	230Vac	
Output voltage error	\pm 5%	
Output frequency range (Hz)	50Hz \pm 0.3Hz/60Hz \pm 0.3Hz	
Maximum output efficiency	>94%	
Overload protection	(102% < load < 125%) \pm 10%: report error and turn off the output after 5 minutes; (125% < load < 150%) \pm 10%: report error and turn off the output after 10 seconds; Load > 150% \pm 10%: report error and turn off the output after 5 seconds;	
Peak power	11000VA	12000VA

Loaded motor capability	3HP	4HP
Output short circuit protection	200ms protection	
Bypass circuit breaker specification	40A	
Rated battery input voltage	51.2V (Minimum starting voltage 44V)	
Battery voltage range	40.0Vdc~60Vdc±0.6Vdc (Undervoltage alarm/shutdown voltage/overvoltage alarm /overvoltage recovery... settable on LCD screen)	
Power-saving mode self-consumption	Load≤25W	
AC charging		
Battery type	Lead acid or lithium battery	
Maximum charge current(can be set)	80A	
Charge current error	±5A _{dc}	
Charge voltage range	40 –60V _{dc}	
Short circuit protection	Circuit breaker	
Circuit breaker specifications	40A	
PV charging		
Maximum PV open circuit voltage	500V _{dc}	
PV operating voltage range	120-500V _{dc}	
MPPT voltage range	90-450V _{dc}	
Battery voltage range	40-60V _{dc}	
Maximum PV input power	6000W	6500W
Maximum PV input current	22A	27A
PV charging current range (can be set)	0-100A	
Charging short circuit protection	Blown fuse	
Wiring protection	Reverse polarity protection	
Hybrid charging Max charger current specifications (AC charger+PV charger)		
Max charger current(can be	0-100A	

set)	
Certified specifications	
Certification	CE(IEC62109-1,2)
EMC certification level	EN61000, C2
Operating temperature range	-10°C to 55°C, > 45°C drop runs
Storage temperature range	-25°C ~ 60°C
Humidity range	5% to 95% (Conformal coating protection)
Noise	≤60dB
Heat dissipation	Forced air cooling, variable speed of fan
Communication interface	USB/RS485(/WiFi/GPRS)/ Dry node control
Size (L*W*D)	428mm*280mm*110mm
Weight (kg)	8.2

Models	SPI4880V150-500/ SPI4880V150-500P	SPI48110V150-500/ SPI48110V150-500P	SPI48120V150-500/ SPI48120V150-500P
Parallel mode			
Permitted parallel number	NO/ 1~6	NO/ 1~6	NO/ 1~6
AC mode			
Rated input voltage	230Vac±5%		
Input voltage range	(170Vac~280Vac)±2% (90Vac-280Vac)±2%		
Frequency	50Hz/60Hz (Auto detection)		
Frequency Range	47±0.3Hz~55±0.3Hz (50Hz); 57±0.3Hz~65±0.3Hz (60Hz);		
Overload/short circuit protection	Circuit breaker		
Maximum charging efficiency	>93%		
Conversion time (bypass and inverter)	10ms (typical)		
AC reverse protection	Yes		
Maximum bypass overload current	60A		

Inverter mode			
Output voltage waveform	Pure sine wave		
Rated output power (VA)	8000	11000	12000
Rated output power (W)	8000	11000	12000
Power factor	1		
Rated output voltage (Vac)	230Vac		
Output voltage error	±5%		
Output frequency range (Hz)	50Hz±0.3Hz/60Hz±0.3Hz		
Maximum output efficiency	>94%		
Overload protection	(102% < load < 125%) ±10%: report error and turn off the output after 5 minutes; (125% < load < 150%) ± 10%: report error and turn off the output after 10 seconds; Load > 150% ±10%: report error and turn off the output after 5 seconds;		
Peak power	16000VA	22000VA	24000VA
Loaded motor capability	5HP	7HP	8HP
Output short circuit protection	200ms protection		
Bypass circuit breaker specification	63A		
Rated battery input voltage	51.2V (Minimum starting voltage 44V)		
Battery voltage range	40.0Vdc~60Vdc±0.6Vdc (Undervoltage alarm/shutdown voltage/overvoltage alarm /overvoltage recovery... settable on LCD screen)		
Power-saving mode self-consumption	Load≤50W		
AC charging			
Battery type	Lead acid or lithium battery		
Maximum charge current(can be set)	120A	150A	150A
Charge current error	±5A _{dc}		
Charge voltage range	40 – 60V _{dc}		
Short circuit protection	Circuit breaker		

Circuit breaker specifications	63A	
PV charging		
MPPT way	2	
Maximum PV open circuit voltage	500Vdc	
PV operating voltage range	120-500Vdc	
MPPT voltage range	90-450Vdc	
Battery voltage range	40-60Vdc	
Maximum PV input power	5500W+5500W	9000W+9000W
Maximum PV input current	22A+22A	27A+27A
PV charging current range (can be set)	0-150A	
Charging short circuit protection	Blown fuse	
Wiring protection	Reverse polarity protection	
Hybrid charging Max charger current specifications (AC charger+PV charger)		
Max charger current(can be set)	0-150A	
Certified specifications		
Certification	CE(IEC62109-1,2)	
EMC certification level	EN61000, C2	
Operating temperature range	-10°C to 55°C, > 45°C drop runs	
Storage temperature range	-25°C ~ 60°C	
Humidity range	5% to 95% (Conformal coating protection)	
Noise	≤60dB	
Heat dissipation	Forced air cooling, variable speed of fan	
Communication interface	USB/RS485(/WiFi/GPRS)/ Dry node control	
Size (L*W*D)	540mm*350mm*120mm	
Weight (kg)	19.5	

